

R&S® AMU200A

Baseband Signal Generator and Fading Simulator

Quick Start Guide



1402.5200.62 – 07

This document describes the R&S®AMU200A, stock no. 1402.4090.02 and its options.

The firmware of the instrument makes use of several valuable open source software packages. The most important of them together with their corresponding open source license and the verbatim license texts are provided on the user documentation CD-ROM (included in delivery).

The OpenSSL Project for use in the OpenSSL Toolkit (<http://www.openssl.org/>) includes cryptographic software written by Eric Young (eay@cryptsoft.com) and software written by Tim Hudson (tjh@cryptsoft.com).

Rohde & Schwarz would like to thank the open source community for their valuable contribution to embedded computing.

© 2011 Rohde & Schwarz GmbH & Co. KG

Muehldorfstr. 15, 81671 Munich, Germany

Phone: +49 89 41 29 - 0

Fax: +49 89 41 29 12 164

E-mail: info@rohde-schwarz.com

Internet: <http://www.rohde-schwarz.com>

Printed in Germany – Subject to change – Data without tolerance limits is not binding.

R&S® is a registered trademark of Rohde & Schwarz GmbH & Co. KG.

Trade names are trademarks of the owners.

The following abbreviations are used throughout this manual: R&S®AMU200A is abbreviated as R&S AMU.

Basic Safety Instructions

Always read through and comply with the following safety instructions!

All plants and locations of the Rohde & Schwarz group of companies make every effort to keep the safety standards of our products up to date and to offer our customers the highest possible degree of safety. Our products and the auxiliary equipment they require are designed, built and tested in accordance with the safety standards that apply in each case. Compliance with these standards is continuously monitored by our quality assurance system. The product described here has been designed, built and tested in accordance with the attached EC Certificate of Conformity and has left the manufacturer's plant in a condition fully complying with safety standards. To maintain this condition and to ensure safe operation, you must observe all instructions and warnings provided in this manual. If you have any questions regarding these safety instructions, the Rohde & Schwarz group of companies will be happy to answer them.

Furthermore, it is your responsibility to use the product in an appropriate manner. This product is designed for use solely in industrial and laboratory environments or, if expressly permitted, also in the field and must not be used in any way that may cause personal injury or property damage. You are responsible if the product is used for any intention other than its designated purpose or in disregard of the manufacturer's instructions. The manufacturer shall assume no responsibility for such use of the product.

The product is used for its designated purpose if it is used in accordance with its product documentation and within its performance limits (see data sheet, documentation, the following safety instructions). Using the product requires technical skills and a basic knowledge of English. It is therefore essential that only skilled and specialized staff or thoroughly trained personnel with the required skills be allowed to use the product. If personal safety gear is required for using Rohde & Schwarz products, this will be indicated at the appropriate place in the product documentation. Keep the basic safety instructions and the product documentation in a safe place and pass them on to the subsequent users.

Observing the safety instructions will help prevent personal injury or damage of any kind caused by dangerous situations. Therefore, carefully read through and adhere to the following safety instructions before and when using the product. It is also absolutely essential to observe the additional safety instructions on personal safety, for example, that appear in relevant parts of the product documentation. In these safety instructions, the word "product" refers to all merchandise sold and distributed by the Rohde & Schwarz group of companies, including instruments, systems and all accessories.





Symbols and safety labels

							
Notice, general danger location Observe product documentation	Caution when handling heavy equipment	Danger of electric shock	Warning! Hot surface	PE terminal	Ground	Ground terminal	Be careful when handling electrostatic sensitive devices

					
ON/OFF supply voltage	Standby indication	Direct current (DC)	Alternating current (AC)	Direct/alternating current (DC/AC)	Device fully protected by double (reinforced) insulation

Tags and their meaning

The following signal words are used in the product documentation in order to warn the reader about risks and dangers.

	indicates a hazardous situation which, if not avoided, will result in death or serious injury.
	indicates a hazardous situation which, if not avoided, could result in death or serious injury.
	indicates a hazardous situation which, if not avoided, could result in minor or moderate injury.
	indicates the possibility of incorrect operation which can result in damage to the product. In the product documentation, the word ATTENTION is used synonymously.

These tags are in accordance with the standard definition for civil applications in the European Economic Area. Definitions that deviate from the standard definition may also exist in other economic areas or military applications. It is therefore essential to make sure that the tags described here are always used only in connection with the related product documentation and the related product. The use of tags in connection with unrelated products or documentation can result in misinterpretation and in personal injury or material damage.

Operating states and operating positions

The product may be operated only under the operating conditions and in the positions specified by the manufacturer, without the product's ventilation being obstructed. If the manufacturer's specifications are not observed, this can result in electric shock, fire and/or serious personal injury or death. Applicable local or national safety regulations and rules for the prevention of accidents must be observed in all work performed.

1. Unless otherwise specified, the following requirements apply to Rohde & Schwarz products: predefined operating position is always with the housing floor facing down, IP protection 2X, pollution severity 2, overvoltage category 2, use only indoors, max. operating altitude 2000 m above sea level, max. transport altitude 4500 m above sea level. A tolerance of $\pm 10\%$ shall apply to the nominal voltage and $\pm 5\%$ to the nominal frequency.
2. Do not place the product on surfaces, vehicles, cabinets or tables that for reasons of weight or stability are unsuitable for this purpose. Always follow the manufacturer's installation instructions when installing the product and fastening it to objects or structures (e.g. walls and shelves). An installation that is not carried out as described in the product documentation could result in personal injury or death.
3. Do not place the product on heat-generating devices such as radiators or fan heaters. The ambient temperature must not exceed the maximum temperature specified in the product documentation or in the data sheet. Product overheating can cause electric shock, fire and/or serious personal injury or death.

Electrical safety

If the information on electrical safety is not observed either at all to the extent necessary, electric shock, fire and/or serious personal injury or death may occur.

1. Prior to switching on the product, always ensure that the nominal voltage setting on the product matches the nominal voltage of the AC supply network. If a different voltage is to be set, the power fuse of the product may have to be changed accordingly.
2. In the case of products of safety class I with movable power cord and connector, operation is permitted only on sockets with an earthing contact and protective earth connection.
3. Intentionally breaking the protective earth connection either in the feed line or in the product itself is not permitted. Doing so can result in the danger of an electric shock from the product. If extension cords or connector strips are implemented, they must be checked on a regular basis to ensure that they are safe to use.
4. If the product does not have a power switch for disconnection from the AC supply network, the plug of the connecting cable is regarded as the disconnecting device. In such cases, always ensure that the power plug is easily reachable and accessible at all times (corresponding to the length of connecting cable, approx. 2 m). Functional or electronic switches are not suitable for providing disconnection from the AC supply network. If products without power switches are integrated into racks or systems, a disconnecting device must be provided at the system level.
5. Never use the product if the power cable is damaged. Check the power cable on a regular basis to ensure that it is in proper operating condition. By taking appropriate safety measures and carefully laying the power cable, you can ensure that the cable will not be damaged and that no one can be hurt by, for example, tripping over the cable or suffering an electric shock.
6. The product may be operated only from TN/TT supply networks fused with max. 16 A (higher fuse only after consulting with the Rohde & Schwarz group of companies).
7. Do not insert the plug into sockets that are dusty or dirty. Insert the plug firmly and all the way into the socket. Otherwise, sparks that result in fire and/or injuries may occur.
8. Do not overload any sockets, extension cords or connector strips; doing so can cause fire or electric shocks.
9. For measurements in circuits with voltages $V_{\text{rms}} > 30 \text{ V}$, suitable measures (e.g. appropriate measuring equipment, fusing, current limiting, electrical separation, insulation) should be taken to avoid any hazards.
10. Ensure that the connections with information technology equipment, e.g. PCs or other industrial computers, comply with the IEC60950-1/EN60950-1 or IEC61010-1/EN 61010-1 standards that apply in each case.
11. Unless expressly permitted, never remove the cover or any part of the housing while the product is in operation. Doing so will expose circuits and components and can lead to injuries, fire or damage to the product.
12. If a product is to be permanently installed, the connection between the PE terminal on site and the product's PE conductor must be made first before any other connection is made. The product may be installed and connected only by a licensed electrician.
13. For permanently installed equipment without built-in fuses, circuit breakers or similar protective devices, the supply circuit must be fused in such a way that anyone who has access to the product, as well as the product itself, is adequately protected from injury or damage.

Basic Safety Instructions

14. Use suitable overvoltage protection to ensure that no overvoltage (such as that caused by a bolt of lightning) can reach the product. Otherwise, the person operating the product will be exposed to the danger of an electric shock.
15. Any object that is not designed to be placed in the openings of the housing must not be used for this purpose. Doing so can cause short circuits inside the product and/or electric shocks, fire or injuries.
16. Unless specified otherwise, products are not liquid-proof (see also section "Operating states and operating positions", item 1. Therefore, the equipment must be protected against penetration by liquids. If the necessary precautions are not taken, the user may suffer electric shock or the product itself may be damaged, which can also lead to personal injury.
17. Never use the product under conditions in which condensation has formed or can form in or on the product, e.g. if the product has been moved from a cold to a warm environment. Penetration by water increases the risk of electric shock.
18. Prior to cleaning the product, disconnect it completely from the power supply (e.g. AC supply network or battery). Use a soft, non-linting cloth to clean the product. Never use chemical cleaning agents such as alcohol, acetone or diluents for cellulose lacquers.

Operation

1. Operating the products requires special training and intense concentration. Make sure that persons who use the products are physically, mentally and emotionally fit enough to do so; otherwise, injuries or material damage may occur. It is the responsibility of the employer/operator to select suitable personnel for operating the products.
2. Before you move or transport the product, read and observe the section titled "Transport".
3. As with all industrially manufactured goods, the use of substances that induce an allergic reaction (allergens) such as nickel cannot be generally excluded. If you develop an allergic reaction (such as a skin rash, frequent sneezing, red eyes or respiratory difficulties) when using a Rohde & Schwarz product, consult a physician immediately to determine the cause and to prevent health problems or stress.
4. Before you start processing the product mechanically and/or thermally, or before you take it apart, be sure to read and pay special attention to the section titled "Waste disposal", item 1.
5. Depending on the function, certain products such as RF radio equipment can produce an elevated level of electromagnetic radiation. Considering that unborn babies require increased protection, pregnant women must be protected by appropriate measures. Persons with pacemakers may also be exposed to risks from electromagnetic radiation. The employer/operator must evaluate workplaces where there is a special risk of exposure to radiation and, if necessary, take measures to avert the potential danger.
6. Should a fire occur, the product may release hazardous substances (gases, fluids, etc.) that can cause health problems. Therefore, suitable measures must be taken, e.g. protective masks and protective clothing must be worn.
7. If a laser product (e.g. a CD/DVD drive) is integrated into a Rohde & Schwarz product, absolutely no other settings or functions may be used as described in the product documentation. The objective is to prevent personal injury (e.g. due to laser beams).

Repair and service

1. The product may be opened only by authorized, specially trained personnel. Before any work is performed on the product or before the product is opened, it must be disconnected from the AC supply network. Otherwise, personnel will be exposed to the risk of an electric shock.
2. Adjustments, replacement of parts, maintenance and repair may be performed only by electrical experts authorized by Rohde & Schwarz. Only original parts may be used for replacing parts relevant to safety (e.g. power switches, power transformers, fuses). A safety test must always be performed after parts relevant to safety have been replaced (visual inspection, PE conductor test, insulation resistance measurement, leakage current measurement, functional test). This helps ensure the continued safety of the product.

Batteries and rechargeable batteries/cells

If the information regarding batteries and rechargeable batteries/cells is not observed either at all or to the extent necessary, product users may be exposed to the risk of explosions, fire and/or serious personal injury, and, in some cases, death. Batteries and rechargeable batteries with alkaline electrolytes (e.g. lithium cells) must be handled in accordance with the EN 62133 standard.

1. Cells must not be taken apart or crushed.
2. Cells or batteries must not be exposed to heat or fire. Storage in direct sunlight must be avoided. Keep cells and batteries clean and dry. Clean soiled connectors using a dry, clean cloth.
3. Cells or batteries must not be short-circuited. Cells or batteries must not be stored in a box or in a drawer where they can short-circuit each other, or where they can be short-circuited by other conductive materials. Cells and batteries must not be removed from their original packaging until they are ready to be used.
4. Keep cells and batteries out of the hands of children. If a cell or a battery has been swallowed, seek medical aid immediately.
5. Cells and batteries must not be exposed to any mechanical shocks that are stronger than permitted.
6. If a cell develops a leak, the fluid must not be allowed to come into contact with the skin or eyes. If contact occurs, wash the affected area with plenty of water and seek medical aid.
7. Improperly replacing or charging cells or batteries that contain alkaline electrolytes (e.g. lithium cells) can cause explosions. Replace cells or batteries only with the matching Rohde & Schwarz type (see parts list) in order to ensure the safety of the product.
8. Cells and batteries must be recycled and kept separate from residual waste. Rechargeable batteries and normal batteries that contain lead, mercury or cadmium are hazardous waste. Observe the national regulations regarding waste disposal and recycling.

Transport

1. The product may be very heavy. Therefore, the product must be handled with care. In some cases, the user may require a suitable means of lifting or moving the product (e.g. with a lift-truck) to avoid back or other physical injuries.

2. Handles on the products are designed exclusively to enable personnel to transport the product. It is therefore not permissible to use handles to fasten the product to or on transport equipment such as cranes, fork lifts, wagons, etc. The user is responsible for securely fastening the products to or on the means of transport or lifting. Observe the safety regulations of the manufacturer of the means of transport or lifting. Noncompliance can result in personal injury or material damage.
3. If you use the product in a vehicle, it is the sole responsibility of the driver to drive the vehicle safely and properly. The manufacturer assumes no responsibility for accidents or collisions. Never use the product in a moving vehicle if doing so could distract the driver of the vehicle. Adequately secure the product in the vehicle to prevent injuries or other damage in the event of an accident.

Waste disposal

1. If products or their components are mechanically and/or thermally processed in a manner that goes beyond their intended use, hazardous substances (heavy-metal dust such as lead, beryllium, nickel) may be released. For this reason, the product may only be disassembled by specially trained personnel. Improper disassembly may be hazardous to your health. National waste disposal regulations must be observed.
2. If handling the product releases hazardous substances or fuels that must be disposed of in a special way, e.g. coolants or engine oils that must be replenished regularly, the safety instructions of the manufacturer of the hazardous substances or fuels and the applicable regional waste disposal regulations must be observed. Also observe the relevant safety instructions in the product documentation. The improper disposal of hazardous substances or fuels can cause health problems and lead to environmental damage.

Informaciones elementales de seguridad

Es imprescindible leer y observar las siguientes instrucciones e informaciones de seguridad!

El principio del grupo de empresas Rohde & Schwarz consiste en tener nuestros productos siempre al día con los estándares de seguridad y de ofrecer a nuestros clientes el máximo grado de seguridad. Nuestros productos y todos los equipos adicionales son siempre fabricados y examinados según las normas de seguridad vigentes. Nuestro sistema de garantía de calidad controla constantemente que sean cumplidas estas normas. El presente producto ha sido fabricado y examinado según el certificado de conformidad adjunto de la UE y ha salido de nuestra planta en estado impecable según los estándares técnicos de seguridad. Para poder preservar este estado y garantizar un funcionamiento libre de peligros, el usuario deberá atenerse a todas las indicaciones, informaciones de seguridad y notas de alerta. El grupo de empresas Rohde & Schwarz está siempre a su disposición en caso de que tengan preguntas referentes a estas informaciones de seguridad.







Además queda en la responsabilidad del usuario utilizar el producto en la forma debida. Este producto está destinado exclusivamente al uso en la industria y el laboratorio o, si ha sido expresamente autorizado, para aplicaciones de campo y de ninguna manera deberá ser utilizado de modo que alguna persona/cosa pueda sufrir daño. El uso del producto fuera de sus fines definidos o sin tener en cuenta las instrucciones del fabricante queda en la responsabilidad del usuario. El fabricante no se hace en ninguna forma responsable de consecuencias a causa del mal uso del producto.

Informaciones elementales de seguridad

Se parte del uso correcto del producto para los fines definidos si el producto es utilizado conforme a las indicaciones de la correspondiente documentación del producto y dentro del margen de rendimiento definido (ver hoja de datos, documentación, informaciones de seguridad que siguen). El uso del producto hace necesarios conocimientos técnicos y ciertos conocimientos del idioma inglés. Por eso se debe tener en cuenta que el producto solo pueda ser operado por personal especializado o personas instruidas en profundidad con las capacidades correspondientes. Si fuera necesaria indumentaria de seguridad para el uso de productos de Rohde & Schwarz, encontraría la información debida en la documentación del producto en el capítulo correspondiente. Guarde bien las informaciones de seguridad elementales, así como la documentación del producto, y entréguelas a usuarios posteriores.

Tener en cuenta las informaciones de seguridad sirve para evitar en lo posible lesiones o daños por peligros de toda clase. Por eso es imprescindible leer detalladamente y comprender por completo las siguientes informaciones de seguridad antes de usar el producto, y respetarlas durante el uso del producto. Deberán tenerse en cuenta todas las demás informaciones de seguridad, como p. ej. las referentes a la protección de personas, que encontrarán en el capítulo correspondiente de la documentación del producto y que también son de obligado cumplimiento. En las presentes informaciones de seguridad se recogen todos los objetos que distribuye el grupo de empresas Rohde & Schwarz bajo la denominación de "producto", entre ellos también aparatos, instalaciones así como toda clase de accesorios.

Símbolos y definiciones de seguridad

							
Aviso: punto de peligro general Observar la documentación del producto	Atención en el manejo de dispositivos de peso elevado	Peligro de choque eléctrico	Advertencia: superficie caliente	Conexión a conductor de protección	Conexión a tierra	Conexión a masa	Aviso: Cuidado en el manejo de dispositivos sensibles a la electrostática (ESD)

					
Tensión de alimentación de PUESTA EN MARCHA / PARADA	Indicación de estado de espera (Standby)	Corriente continua (DC)	Corriente alterna (AC)	Corriente continua / Corriente alterna (DC/AC)	El aparato está protegido en su totalidad por un aislamiento doble (reforzado)

Palabras de señal y su significado

En la documentación del producto se utilizan las siguientes palabras de señal con el fin de advertir contra riesgos y peligros.



PELIGRO identifica un peligro inminente con riesgo elevado que provocará muerte o lesiones graves si no se evita.



ADVERTENCIA identifica un posible peligro con riesgo medio de provocar muerte o lesiones (graves) si no se evita.



ATENCIÓN identifica un peligro con riesgo reducido de provocar lesiones leves o moderadas si no se evita.



AVISO indica la posibilidad de utilizar mal el producto y, como consecuencia, dañarlo.

En la documentación del producto se emplea de forma sinónima el término CUIDADO.

Las palabras de señal corresponden a la definición habitual para aplicaciones civiles en el área económica europea. Pueden existir definiciones diferentes a esta definición en otras áreas económicas o en aplicaciones militares. Por eso se deberá tener en cuenta que las palabras de señal aquí descritas sean utilizadas siempre solamente en combinación con la correspondiente documentación del producto y solamente en combinación con el producto correspondiente. La utilización de las palabras de señal en combinación con productos o documentaciones que no les correspondan puede llevar a interpretaciones equivocadas y tener por consecuencia daños en personas u objetos.

Estados operativos y posiciones de funcionamiento

El producto solamente debe ser utilizado según lo indicado por el fabricante respecto a los estados operativos y posiciones de funcionamiento sin que se obstruya la ventilación. Si no se siguen las indicaciones del fabricante, pueden producirse choques eléctricos, incendios y/o lesiones graves con posible consecuencia de muerte. En todos los trabajos deberán ser tenidas en cuenta las normas nacionales y locales de seguridad del trabajo y de prevención de accidentes.

1. Si no se convino de otra manera, es para los productos Rohde & Schwarz válido lo que sigue: como posición de funcionamiento se define por principio la posición con el suelo de la caja para abajo, modo de protección IP 2X, grado de suciedad 2, categoría de sobrecarga eléctrica 2, uso solamente en estancias interiores, utilización hasta 2000 m sobre el nivel del mar, transporte hasta 4500 m sobre el nivel del mar. Se aplicará una tolerancia de $\pm 10\%$ sobre el voltaje nominal y de $\pm 5\%$ sobre la frecuencia nominal.
2. No sitúe el producto encima de superficies, vehículos, estantes o mesas, que por sus características de peso o de estabilidad no sean aptos para él. Siga siempre las instrucciones de instalación del fabricante cuando instale y asegure el producto en objetos o estructuras (p. ej. paredes y estantes). Si se realiza la instalación de modo distinto al indicado en la documentación del producto, pueden causarse lesiones o incluso la muerte.
3. No ponga el producto sobre aparatos que generen calor (p. ej. radiadores o calefactores). La temperatura ambiente no debe superar la temperatura máxima especificada en la documentación del producto o en la hoja de datos. En caso de sobrecalentamiento del producto, pueden producirse choques eléctricos, incendios y/o lesiones graves con posible consecuencia de muerte.

Seguridad eléctrica

Si no se siguen (o se siguen de modo insuficiente) las indicaciones del fabricante en cuanto a seguridad eléctrica, pueden producirse choques eléctricos, incendios y/o lesiones graves con posible consecuencia de muerte.

1. Antes de la puesta en marcha del producto se deberá comprobar siempre que la tensión preseleccionada en el producto coincida con la de la red de alimentación eléctrica. Si es necesario modificar el ajuste de tensión, también se deberán cambiar en caso dado los fusibles correspondientes del producto.
2. Los productos de la clase de protección I con alimentación móvil y enchufe individual solamente podrán enchufarse a tomas de corriente con contacto de seguridad y con conductor de protección conectado.
3. Queda prohibida la interrupción intencionada del conductor de protección, tanto en la toma de corriente como en el mismo producto. La interrupción puede tener como consecuencia el riesgo de que el producto sea fuente de choques eléctricos. Si se utilizan cables alargadores o regletas de enchufe, deberá garantizarse la realización de un examen regular de los mismos en cuanto a su estado técnico de seguridad.
4. Si el producto no está equipado con un interruptor para desconectarlo de la red, se deberá considerar el enchufe del cable de conexión como interruptor. En estos casos se deberá asegurar que el enchufe siempre sea de fácil acceso (de acuerdo con la longitud del cable de conexión, aproximadamente 2 m). Los interruptores de función o electrónicos no son aptos para el corte de la red eléctrica. Si los productos sin interruptor están integrados en bastidores o instalaciones, se deberá colocar el interruptor en el nivel de la instalación.
5. No utilice nunca el producto si está dañado el cable de conexión a red. Compruebe regularmente el correcto estado de los cables de conexión a red. Asegúrese, mediante las medidas de protección y de instalación adecuadas, de que el cable de conexión a red no pueda ser dañado o de que nadie pueda ser dañado por él, p. ej. al tropezar o por un choque eléctrico.
6. Solamente está permitido el funcionamiento en redes de alimentación TN/TT aseguradas con fusibles de 16 A como máximo (utilización de fusibles de mayor amperaje solo previa consulta con el grupo de empresas Rohde & Schwarz).
7. Nunca conecte el enchufe en tomas de corriente sucias o llenas de polvo. Introduzca el enchufe por completo y fuertemente en la toma de corriente. La no observación de estas medidas puede provocar chispas, fuego y/o lesiones.
8. No sobrecargue las tomas de corriente, los cables alargadores o las regletas de enchufe ya que esto podría causar fuego o choques eléctricos.
9. En las mediciones en circuitos de corriente con una tensión $U_{\text{eff}} > 30 \text{ V}$ se deberán tomar las medidas apropiadas para impedir cualquier peligro (p. ej. medios de medición adecuados, seguros, limitación de tensión, corte protector, aislamiento etc.).
10. Para la conexión con dispositivos informáticos como un PC o un ordenador industrial, debe comprobarse que éstos cumplan los estándares IEC60950-1/EN60950-1 o IEC61010-1/EN 61010-1 válidos en cada caso.
11. A menos que esté permitido expresamente, no retire nunca la tapa ni componentes de la carcasa mientras el producto esté en servicio. Esto pone a descubierto los cables y componentes eléctricos y puede causar lesiones, fuego o daños en el producto.

12. Si un producto se instala en un lugar fijo, se deberá primero conectar el conductor de protección fijo con el conductor de protección del producto antes de hacer cualquier otra conexión. La instalación y la conexión deberán ser efectuadas por un electricista especializado.
13. En el caso de dispositivos fijos que no estén provistos de fusibles, interruptor automático ni otros mecanismos de seguridad similares, el circuito de alimentación debe estar protegido de modo que todas las personas que puedan acceder al producto, así como el producto mismo, estén a salvo de posibles daños.
14. Todo producto debe estar protegido contra sobretensión (debida p. ej. a una caída del rayo) mediante los correspondientes sistemas de protección. Si no, el personal que lo utilice quedará expuesto al peligro de choque eléctrico.
15. No debe introducirse en los orificios de la caja del aparato ningún objeto que no esté destinado a ello. Esto puede producir cortocircuitos en el producto y/o puede causar choques eléctricos, fuego o lesiones.
16. Salvo indicación contraria, los productos no están impermeabilizados (ver también el capítulo "Estados operativos y posiciones de funcionamiento", punto 1). Por eso es necesario tomar las medidas necesarias para evitar la entrada de líquidos. En caso contrario, existe peligro de choque eléctrico para el usuario o de daños en el producto, que también pueden redundar en peligro para las personas.
17. No utilice el producto en condiciones en las que pueda producirse o ya se hayan producido condensaciones sobre el producto o en el interior de éste, como p. ej. al desplazarlo de un lugar frío a otro caliente. La entrada de agua aumenta el riesgo de choque eléctrico.
18. Antes de la limpieza, desconecte por completo el producto de la alimentación de tensión (p. ej. red de alimentación o batería). Realice la limpieza de los aparatos con un paño suave, que no se deshilache. No utilice bajo ningún concepto productos de limpieza químicos como alcohol, acetona o diluyentes para lacas nitrocelulósicas.

Funcionamiento

1. El uso del producto requiere instrucciones especiales y una alta concentración durante el manejo. Debe asegurarse que las personas que manejen el producto estén a la altura de los requerimientos necesarios en cuanto a aptitudes físicas, psíquicas y emocionales, ya que de otra manera no se pueden excluir lesiones o daños de objetos. El empresario u operador es responsable de seleccionar el personal usuario apto para el manejo del producto.
2. Antes de desplazar o transportar el producto, lea y tenga en cuenta el capítulo "Transporte".
3. Como con todo producto de fabricación industrial no puede quedar excluida en general la posibilidad de que se produzcan alergias provocadas por algunos materiales empleados, los llamados alérgenos (p. ej. el níquel). Si durante el manejo de productos Rohde & Schwarz se producen reacciones alérgicas, como p. ej. irritaciones cutáneas, estornudos continuos, enrojecimiento de la conjuntiva o dificultades respiratorias, debe avisarse inmediatamente a un médico para investigar las causas y evitar cualquier molestia o daño a la salud.
4. Antes de la manipulación mecánica y/o térmica o el desmontaje del producto, debe tenerse en cuenta imprescindiblemente el capítulo "Eliminación", punto 1.

5. Ciertos productos, como p. ej. las instalaciones de radiocomunicación RF, pueden a causa de su función natural, emitir una radiación electromagnética aumentada. Deben tomarse todas las medidas necesarias para la protección de las mujeres embarazadas. También las personas con marcapasos pueden correr peligro a causa de la radiación electromagnética. El empresario/operador tiene la obligación de evaluar y señalar las áreas de trabajo en las que exista un riesgo elevado de exposición a radiaciones.
6. Tenga en cuenta que en caso de incendio pueden desprenderse del producto sustancias tóxicas (gases, líquidos etc.) que pueden generar daños a la salud. Por eso, en caso de incendio deben usarse medidas adecuadas, como p. ej. máscaras antigás e indumentaria de protección.
7. En caso de que un producto Rohde & Schwarz contenga un producto láser (p. ej. un lector de CD/DVD), no debe usarse ninguna otra configuración o función aparte de las descritas en la documentación del producto, a fin de evitar lesiones (p. ej. debidas a irradiación láser).

Reparación y mantenimiento

1. El producto solamente debe ser abierto por personal especializado con autorización para ello. Antes de manipular el producto o abrirlo, es obligatorio desconectarlo de la tensión de alimentación, para evitar toda posibilidad de choque eléctrico.
2. El ajuste, el cambio de partes, el mantenimiento y la reparación deberán ser efectuadas solamente por electricistas autorizados por Rohde & Schwarz. Si se reponen partes con importancia para los aspectos de seguridad (p. ej. el enchufe, los transformadores o los fusibles), solamente podrán ser sustituidos por partes originales. Después de cada cambio de partes relevantes para la seguridad deberá realizarse un control de seguridad (control a primera vista, control del conductor de protección, medición de resistencia de aislamiento, medición de la corriente de fuga, control de funcionamiento). Con esto queda garantizada la seguridad del producto.

Baterías y acumuladores o celdas

Si no se siguen (o se siguen de modo insuficiente) las indicaciones en cuanto a las baterías y acumuladores o celdas, pueden producirse explosiones, incendios y/o lesiones graves con posible consecuencia de muerte. El manejo de baterías y acumuladores con electrolitos alcalinos (p. ej. celdas de litio) debe seguir el estándar EN 62133.

1. No deben desmontarse, abrirse ni triturarse las celdas.
2. Las celdas o baterías no deben someterse a calor ni fuego. Debe evitarse el almacenamiento a la luz directa del sol. Las celdas y baterías deben mantenerse limpias y secas. Limpiar las conexiones sucias con un paño seco y limpio.
3. Las celdas o baterías no deben cortocircuitarse. Es peligroso almacenar las celdas o baterías en estuches o cajones en cuyo interior puedan cortocircuitarse por contacto recíproco o por contacto con otros materiales conductores. No deben extraerse las celdas o baterías de sus embalajes originales hasta el momento en que vayan a utilizarse.
4. Mantener baterías y celdas fuera del alcance de los niños. En caso de ingestión de una celda o batería, avisar inmediatamente a un médico.
5. Las celdas o baterías no deben someterse a impactos mecánicos fuertes indebidos.

Informaciones elementales de seguridad

6. En caso de falta de estanqueidad de una celda, el líquido vertido no debe entrar en contacto con la piel ni los ojos. Si se produce contacto, lavar con agua abundante la zona afectada y avisar a un médico.
7. En caso de cambio o recarga inadecuados, las celdas o baterías que contienen electrolitos alcalinos (p. ej. las celdas de litio) pueden explotar. Para garantizar la seguridad del producto, las celdas o baterías solo deben ser sustituidas por el tipo Rohde & Schwarz correspondiente (ver lista de recambios).
8. Las baterías y celdas deben reciclarse y no deben tirarse a la basura doméstica. Las baterías o acumuladores que contienen plomo, mercurio o cadmio deben tratarse como residuos especiales. Respete en esta relación las normas nacionales de eliminación y reciclaje.

Transporte

1. El producto puede tener un peso elevado. Por eso es necesario desplazarlo o transportarlo con precaución y, si es necesario, usando un sistema de elevación adecuado (p. ej. una carretilla elevadora), a fin de evitar lesiones en la espalda u otros daños personales.
2. Las asas instaladas en los productos sirven solamente de ayuda para el transporte del producto por personas. Por eso no está permitido utilizar las asas para la sujeción en o sobre medios de transporte como p. ej. grúas, carretillas elevadoras de horquilla, carros etc. Es responsabilidad suya fijar los productos de manera segura a los medios de transporte o elevación. Para evitar daños personales o daños en el producto, siga las instrucciones de seguridad del fabricante del medio de transporte o elevación utilizado.
3. Si se utiliza el producto dentro de un vehículo, recae de manera exclusiva en el conductor la responsabilidad de conducir el vehículo de manera segura y adecuada. El fabricante no asumirá ninguna responsabilidad por accidentes o colisiones. No utilice nunca el producto dentro de un vehículo en movimiento si esto pudiera distraer al conductor. Asegure el producto dentro del vehículo debidamente para evitar, en caso de un accidente, lesiones u otra clase de daños.

Eliminación

1. Si se trabaja de manera mecánica y/o térmica cualquier producto o componente más allá del funcionamiento previsto, pueden liberarse sustancias peligrosas (polveros con contenido de metales pesados como p. ej. plomo, berilio o níquel). Por eso el producto solo debe ser desmontado por personal especializado con formación adecuada. Un desmontaje inadecuado puede ocasionar daños para la salud. Se deben tener en cuenta las directivas nacionales referentes a la eliminación de residuos.
2. En caso de que durante el trato del producto se formen sustancias peligrosas o combustibles que deban tratarse como residuos especiales (p. ej. refrigerantes o aceites de motor con intervalos de cambio definidos), deben tenerse en cuenta las indicaciones de seguridad del fabricante de dichas sustancias y las normas regionales de eliminación de residuos. Tenga en cuenta también en caso necesario las indicaciones de seguridad especiales contenidas en la documentación del producto. La eliminación incorrecta de sustancias peligrosas o combustibles puede causar daños a la salud o daños al medio ambiente.

Kundeninformation zur Batterieverordnung (BattV)

Dieses Gerät enthält eine schadstoffhaltige Batterie. Diese darf nicht mit dem Hausmüll entsorgt werden.

Nach Ende der Lebensdauer darf die Entsorgung nur über eine Rohde&Schwarz-Kundendienststelle oder eine geeignete Sammelstelle erfolgen.

Safety Regulations for Batteries (according to BattV)

This equipment houses a battery containing harmful substances that must not be disposed of as normal household waste.

After its useful life, the battery may only be disposed of at a Rohde & Schwarz service center or at a suitable depot.

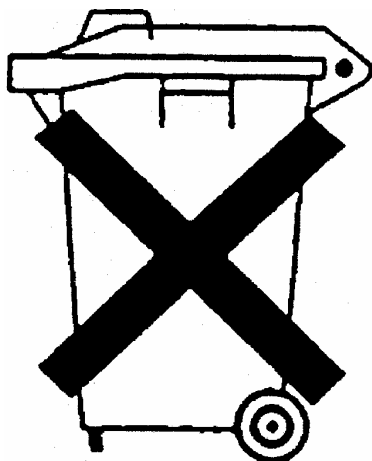

Normas de Seguridad para Baterías (Según BattV)

Este equipo lleva una batería que contiene sustancias perjudiciales, que no se debe desechar en los contenedores de basura domésticos.

Después de la vida útil, la batería sólo se podrá eliminar en un centro de servicio de Rohde & Schwarz o en un depósito apropiado.

Consignes de sécurité pour batteries (selon BattV)

Cet appareil est équipé d'une pile comprenant des substances nocives. Ne jamais la jeter dans une poubelle pour ordures ménagères.

Une pile usagée doit uniquement être éliminée par un centre de service client de Rohde & Schwarz ou peut être collectée pour être traitée spécialement comme déchets dangereux.

Customer Information Regarding Product Disposal

The German Electrical and Electronic Equipment (ElektroG) Act is an implementation of the following EC directives:

- 2002/96/EC on waste electrical and electronic equipment (WEEE) and
- 2002/95/EC on the restriction of the use of certain hazardous substances in electrical and electronic equipment (RoHS).

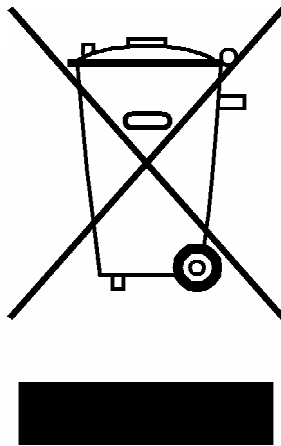

Product labeling in accordance with EN 50419

Once the lifetime of a product has ended, this product must not be disposed of in the standard domestic refuse. Even disposal via the municipal collection points for waste electrical and electronic equipment is not permitted.

Rohde & Schwarz GmbH & Co. KG has developed a disposal concept for the environmental-friendly disposal or recycling of waste material and fully assumes its obligation as a producer to take back and dispose of electrical and electronic waste in accordance with the ElektroG Act.

Please contact your local service representative to dispose of the product.



Qualitätszertifikat

Certificate of quality

Certificat de qualité

Certified Quality System
ISO 9001

Certified Environmental System
ISO 14001

Sehr geehrter Kunde,

Sie haben sich für den Kauf eines Rohde&Schwarz-Produktes entschieden. Hiermit erhalten Sie ein nach modernsten Fertigungsmethoden hergestelltes Produkt. Es wurde nach den Regeln unseres Qualitätsmanagementsystems entwickelt, gefertigt und geprüft. Das Rohde&Schwarz-Qualitätsmanagementsystem ist u.a. nach ISO9001 und ISO14001 zertifiziert.

Der Umwelt verpflichtet

- ▮ Energie-effiziente, RoHS-konforme Produkte
- ▮ Kontinuierliche Weiterentwicklung nachhaltiger Umweltkonzepte
- ▮ ISO 14001-zertifiziertes Umweltmanagementsystem

Dear Customer,

You have decided to buy a Rohde&Schwarz product. You are thus assured of receiving a product that is manufactured using the most modern methods available. This product was developed, manufactured and tested in compliance with our quality management system standards. The Rohde&Schwarz quality management system is certified according to standards such as ISO9001 and ISO14001.

Environmental commitment

- ▮ Energy-efficient products
- ▮ Continuous improvement in environmental sustainability
- ▮ ISO 14001-certified environmental management system

Cher client,

Vous avez choisi d'acheter un produit Rohde&Schwarz. Vous disposez donc d'un produit fabriqué d'après les méthodes les plus avancées. Le développement, la fabrication et les tests respectent nos normes de gestion qualité. Le système de gestion qualité de Rohde&Schwarz a été homologué, entre autres, conformément aux normes ISO9001 et ISO14001.

Engagement écologique

- ▮ Produits à efficience énergétique
- ▮ Amélioration continue de la durabilité environnementale
- ▮ Système de gestion de l'environnement certifié selon ISO 14001



ROHDE & SCHWARZ

CE Declaration of Conformity



Certificate No.: 2010-16

This is to certify that:

Equipment type	Stock No.	Designation
AMU200A	1402.4090.02	BASEBAND SIGNALGENERATOR

complies with the provisions of the Directive of the Council of the European Union on the approximation of the laws of the Member States

- relating to electrical equipment for use within defined voltage limits (2006/95/EC)
- relating to electromagnetic compatibility (2004/108/EC)

Conformity is proven by compliance with the following standards:

EN 61010-1: 2001
EN 61326-1: 2006
EN 61326-2-1: 2006
EN 55011: 2007 + A2: 2007, class B, except when AMU-B18 is installed then class A
EN 61000-3-2: 2006
EN 61000-3-3: 1995 + A1: 2001 + A2: 2005

For the assessment of electromagnetic compatibility, the limits of radio interference for Class B equipment as well as the immunity to interference for operation in industry have been used as a basis.

ROHDE & SCHWARZ GmbH & Co. KG
Mühldorfstr. 15, D-81671 München

Munich, 2010-02-17

Central Quality Management MF-QZ / Radde

CE

E-1

Customer Support

Technical support – where and when you need it

For quick, expert help with any Rohde & Schwarz equipment, contact one of our Customer Support Centers. A team of highly qualified engineers provides telephone support and will work with you to find a solution to your query on any aspect of the operation, programming or applications of Rohde & Schwarz equipment.

Up-to-date information and upgrades

To keep your instrument up-to-date and to be informed about new application notes related to your instrument, please send an e-mail to the Customer Support Center stating your instrument and your wish. We will take care that you will get the right information.

Europe, Africa, Middle East

Phone +49 89 4129 12345
customersupport@rohde-schwarz.com

North America

Phone 1-888-TEST-RSA (1-888-837-8772)
customer.support@rsa.rohde-schwarz.com

Latin America

Phone +1-410-910-7988
customersupport.la@rohde-schwarz.com

Asia/Pacific

Phone +65 65 13 04 88
customersupport.asia@rohde-schwarz.com

China

Phone +86-800-810-8228 /
+86-400-650-5896
customersupport.china@rohde-schwarz.com



Contents

1	Preface	7
1.1	Documentation Overview.....	7
1.2	Typographical Conventions.....	8
2	Preparing for Use	11
2.1	Front Panel Tour.....	11
2.1.1	Utility Keys.....	12
2.1.2	Standby LEDs and Standby Key.....	13
2.1.3	Display.....	13
2.1.4	Setup Keys.....	14
2.1.4.1	Keys for Setting Paramters.....	14
2.1.4.2	Display Keys.....	14
2.1.5	Keypad for data entry.....	15
2.1.6	Rotary Knob and Navigation Keys.....	17
2.1.7	Front Panel Connectors.....	17
2.2	Rear Panel Tour.....	19
2.2.1	Description of the Connectors.....	19
2.3	Putting into Operation.....	24
2.3.1	Unpacking and Checking the Instrument.....	25
2.3.2	Placing or Mounting the Instrument.....	26
2.3.3	Connecting the Instrument to the AC Supply.....	26
2.3.4	Starting the Instrument.....	27
2.3.4.1	Standby and Ready state.....	27
2.3.4.2	Start Display and Booting.....	27
2.3.4.3	Function Check.....	28
2.3.4.4	Default Settings.....	28
2.3.5	Shutting Down the Instrument.....	29
2.4	Connecting External Accessories.....	30
2.4.1	Connecting USB Devices.....	30
2.4.2	Connecting a Monitor.....	31
2.5	Windows Operating System.....	32
2.5.1	Virus Protection.....	32

2.5.2	Service Packs and Updates.....	33
2.5.3	Login.....	33
2.5.4	Accessing the Start Menu.....	33
2.6	Setting Up a Network (LAN) Connection.....	34
2.6.1	Connecting the Instrument to the Network.....	34
2.6.2	Assigning the IP Address.....	35
2.6.3	Using computer names.....	36
2.6.4	Changing the Windows Firewall Settings.....	36
2.6.5	Working with Directories.....	37
2.7	Remote Access via an External Controller.....	38
2.7.1	Using a Web Browser for Remote Access.....	40
2.7.2	Remote Desktop Connection.....	40
2.7.3	Remote Access via Ultr@VNC.....	43
2.8	Using Virus-Protection Software.....	49
2.9	LXI Configuration.....	50
2.9.1	LXI Browser Interface.....	52
2.9.2	LAN Configuration.....	53
2.9.2.1	Advanced LAN Configuration.....	54
2.9.2.2	Ping.....	54
3	Getting Started.....	57
3.1	Brief Introduction to the Instrument's Concept.....	57
3.2	Applications of the Instrument.....	59
3.2.1	Generation of Digitally Modulated Signals.....	60
3.2.2	One Path Instrument.....	61
3.2.3	Two Path Instrument.....	62
3.3	Baseband Section.....	63
3.3.1	Description of Individual Diagram Blocks of the Baseband Section.....	65
3.4	Example of Setup.....	68
4	Manual Operation.....	79
4.1	Key Features.....	79
4.2	Display.....	84
4.2.1	Settings Displayed in the Header Section.....	84
4.2.2	Status Information and Messages.....	85

4.2.2.1	Status Information.....	85
4.2.2.2	Messages.....	85
4.2.2.3	Volatile messages.....	85
4.2.2.4	Permanent Messages.....	86
4.2.3	Info Window.....	86
4.2.4	Block Diagram	87
4.2.4.1	Function Blocks in the Block Diagram.....	88
4.2.4.2	Signal Flow and Input/Output Symbols in the Block Diagram.....	88
4.2.5	Winbar and Softkeys.....	89
4.2.6	Structure of the Dialogs.....	89
4.2.7	Graphical Display of Output Signal Characteristics.....	90
4.3	Accessing Dialogs.....	91
4.4	Setting Parameters.....	92
4.4.1	Working with the Cursor.....	93
4.4.2	Selecting a Control Element.....	94
4.4.3	Switching Parameters On/Off.....	94
4.4.4	Entering a Value.....	94
4.4.5	Working with Units	96
4.4.6	Selecting a Value from a List.....	97
4.4.7	Terminating Entries with Confirmation.....	97
4.4.8	Restoring the Previous Value.....	98
4.5	Editors.....	99
4.5.1	Working with Data Editor.....	99
4.5.2	Working with Control and Marker List Editor.....	101
4.6	How to Use the Help System.....	104
4.7	File Management.....	106
4.7.1	File Select Dialog.....	108
4.7.2	File Manager.....	109
4.7.2.1	Extensions for User Files.....	110
4.8	Legend of Front-Panel Controls.....	112
4.8.1	Front Panel Key Emulation.....	114
4.8.2	On-screen Keyboard.....	114
A	Hardware Interfaces.....	115

A.1	GPIB Bus Interface.....	115
A.2	AUX I/O Connector.....	116
A.3	Monitor Connector (MONITOR).....	118
A.4	BERT Connector.....	118
	Index.....	121

1 Preface

1.1 Documentation Overview

The user documentation for the R&S AMU consists of the following parts:

- Online Help system on the instrument,
- "Quick Start Guide" printed manual,
- Documentation CD-ROM with:
 - Online help system (*.chm) as a standalone help,
 - Operating Manuals for base unit and options,
 - Service Manual,
 - Data sheet and specifications,
 - Links to useful sites on the R&S internet.

Online Help

The Online Help is embedded in the instrument's firmware. It offers quick, context-sensitive access to the complete information needed for operation and programming. The online help contains help on operating the R&S AMU and all available options.

Quick Start Guide

This manual is delivered with the instrument in printed form and in PDF format on the Documentation CD-ROM. It provides the information needed to set up and start working with the instrument. Basic operations and an example of setup are described. The manual includes also general information, e.g., Safety Instructions.

Operating Manuals

The Operating Manuals are a supplement to the Quick Start Guide. Operating Manuals are provided for the base unit and each additional (software) option.

These manuals are available in PDF format - in printable form - on the Documentation CD-ROM delivered with the instrument. In the Operating Manual for the base unit, all instrument functions are described in detail. Furthermore, it provides an introduction to remote control and a complete description of the remote control commands with programming examples. Information on maintenance, instrument interfaces and error messages is also given.

In the individual option manuals, the specific instrument functions of the option are described in detail. For additional information on default settings and parameters, refer to the data sheets. Basic information on operating the R&S AMU is not included in the option manuals.

The following Operating Manuals are available for the R&S AMU:

- Fading Simulator
- Digital Standard GSM/EDGE, incl. EDGE+

- Digital Standard 3GPP FDD, 3GPP FDD enhanced MS/BS tests incl. HSDPA, 3GPP FDD HSUPA, 3GPP FDD HSPA+
- Digital Standard GPS and Assisted GPS
- Digital Standard CDMA2000® incl. 1xEV-DV
- Digital Standard 1xEV-DO Rev. A
- Digital Standard IEEE 802.11 (a/b/c) WLAN
- Digital Standard IEEE 802.16 WiMAX
- Digital Standard TD-SCDMA, inclusive TD-SCDMA enhanced features
- Digital Standard DVB-H
- Digital Standard DAB / T-DMB
- Digital Standard IEEE 802.11n WLAN-N
- Digital Standard EUTRA/LTE
- Digital Standard XM Radio
- FM Stereo / RDS
- Digital Standard Sirius Radio
- Digital Standard TETRA Release 2
- Digital Standard Bluetooth®Enhanced Data Rate

These manuals can also be orderd in printed form (see ordering information in the data sheet).

Service Manual

This Service Manual is available in PDF format - in printable form - on the Documentation CD-ROM delivered with the instrument. It describes how to check compliance with rated specifications, on instrument function, repair, troubleshooting and fault elimination. It contains all information required for repairing the instrument by the replacement of modules.

This manual can also be orderd in printed form (see ordering information in the data sheet).

Release Notes

The release notes describe new and modified functions, eliminated problems, and last minute changes to the documentation. The corresponding firmware version is indicated on the title page of the release notes. The current release notes are provided in the Internet.

1.2 Typographical Conventions

The following text markers are used throughout this documentation:

Typographical Conventions

Convention	Description
"Graphical user interface elements"	All names of graphical user interface elements on the screen, such as dialog boxes, menus, options, buttons, and softkeys are enclosed by quotation marks.
KEYS	Key names are written in capital letters.
File names, commands, program code	File names, commands, coding samples and screen output are distinguished by their font.
<i>Input</i>	Input to be entered by the user is displayed in italics.
Links	Links that you can click are displayed in blue font.
"References"	References to other parts of the documentation are enclosed by quotation marks.

2 Preparing for Use

The following topics will help you to get familiar with the instrument and perform the first steps:

- [Front Panel Tour](#)
- [Rear Panel Tour](#)
- [Putting into Operation](#)

This section explains the control elements and connectors of the Signal Generator R&S AMU with the aid of the front and rear views and describes how to put the instrument into operation. It also describes the connection of peripherals such as printer, keyboard or mouse. Specifications of interfaces can be found in the data sheet.

The [chapter 3, "Getting Started"](#), on page 57 of this manual provides an overview of the generator functions and introduces the operating concept. Detailed operating instructions and an overview of menus follow in [chapter 4, "Manual Operation"](#), on page 79.

For all reference information concerning manual and remote control of the instrument refer to the online help system or its printed/printable version. A more detailed description of the hardware connectors and interfaces is also part of the help system.

2.1 Front Panel Tour

The front panel of the R&S Signal Generator consists of the VGA display with the softkey area, some utility keys (left side) and the hardkey area with connectors and control interfaces (right side). The subsequent sections provide brief explanations on the controls and connectors, the hardkey area and the front panel.



For more detailed information, refer to the corresponding description in the Operating Manual.

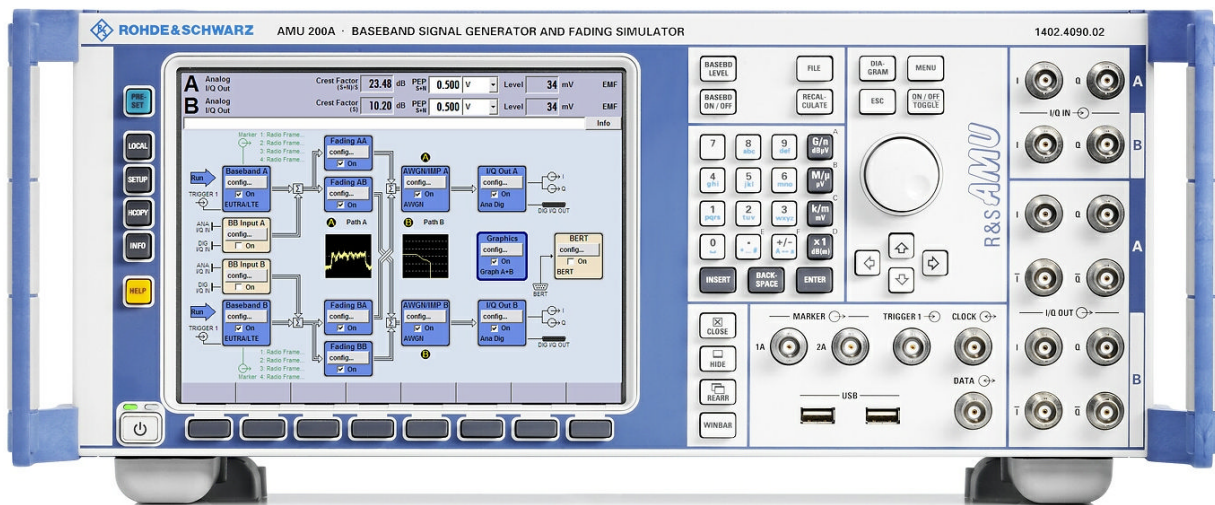

Fig. 2-1: Front panel view

2.1.1 Utility Keys



The keys to the left of the display cause the R&S AMU to return to a definite instrument state and provide information on the instrument and assistance.

For more information refer to chapter "Instrument Settings" in the Operating Manual.

PRESET

Sets the instrument to a defined state (see [chapter 2.3.4.4, "Default Settings"](#), on page 28).

LOCAL

Switches from remote control to local (manual) control.

SETUP

Opens the "Setup" dialog for configuring presettings.

HCOPI

Opens the "Hardcopy" menu for configuring and starting printing.

INFO

Displays status messages, error messages and warnings.

HELP

Displays context-sensitive help text.

2.1.2 Standby LEDs and Standby Key

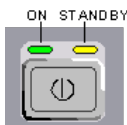

The standby LEDs and the ON/STANDBY key are located in the bottom left corner of the front panel.

The ON/STANDBY key toggles the instrument between standby and ready state (indicated by the standby LEDs).

The standby LEDs indicate the instrument states as follow:

- the green LED (left) is on when the instrument is ready for operation,
- the yellow LED (right) is on in the standby mode.

See also [chapter 2.3.4.1, "Standby and Ready state"](#), on page 27.

2.1.3 Display

The display clearly shows all main settings and signal generator states.

The display is divided into the following sections:

- Level display with info line
 - Level and PEP settings containing auxiliary information such as insertion loss, crest factor and load type.
In two-path instruments, level and PEP are displayed in two lines.
 - Status messages
 - Brief error messages; to access an window with detailed information for a message, use the INFO key.
- Block diagram
 - The block diagram shows the current configuration and the signal flow in the generator with the aid of function blocks containing an on/off switch. Selecting a function block opens a list of associated setting menus. Active menus, info windows and graphs are displayed on top of the block diagram. The block diagram can be displayed in the foreground anytime with the **DIAGRAM** key.
- "Winbar" with labelled softkeys
 - Open menus are indicated by a labelled button in the "Winbar". The buttons determine the softkey functions for front-panel control. When a button or softkey is pressed, the associated menu is displayed either in the foreground or minimized in the "Winbar". If required, the WINBAR is covered by a row of buttons to which menu-specific functions of the active menu are assigned. By pressing the WINBAR key, the "Winbar" can be displayed in the foreground again. This allows the user to toggle between the button and softkey functions.

For detailed information, see [chapter 4.2, "Display"](#), on page 84.

2.1.4 Setup Keys

The keys to the right of the display set parameters, select views and control the windows.

2.1.4.1 Keys for Setting Parameters

These keys provide direct access to the settings in the header of the instrument and can be used for fast changing the state of the baseband signal.

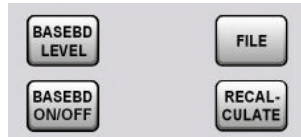

For more information refer to chapter "Instrument Functions" in the Operating Manual.

BASEBD LEVEL

Activates the baseband level entry. In the two-path mode, the baseband level entry field that was active last is activated. Pressing the key again activates the baseband level entry for the second path.

BASEBD ON/OFF

Switches the Baseband signal on and off. In the two-path mode, the BASEBD ON/OFF key switches all signals off. A second stroke restores the status that was active before the last switch-off. "I/Q OUT OFF" is displayed in the status bar.

FILE

Activates the menu for storing or loading files (see [chapter 4.7, "File Management"](#), on page 106).

RECALCULATE

Starts the recalculation of instrument settings.

If time-consuming calculations are required, the active modulation is automatically switched off and the calculation is interrupted to allow the user to make further settings. Calculation is restarted by a keystroke and the modulation is switched on again after the calculation is completed.

2.1.4.2 Display Keys



The keys on top of the rotary knob and the keys below the numeric key pad arrange different windows on the display.

DIAGRAM

Brings the block diagram to the foreground. Active menus are minimized.

Active menus are indicated by the buttons in the "Winbar".

ESC

The function of this key depends on the current cursor position.

- Calls the next higher selection level.
- Closes the open window without accepting new entries; the old value or parameter is retained.
- In dialog boxes that contain a "Cancel" button it activates that button.
- Closes all kinds of dialog boxes, if the edit mode is not active.
- Quits the edit mode, if the edit mode is active.
- Switches between different entry fields of a menu.
- Shifts the entry cursor from the header display to the previously active menu, or to the previously highlighted block in the block diagram if no menu is active.
- Shifts the cursor from a function block in the diagram to the first item in the "Winbar". If no menus are open, the current cursor position remains unchanged.

TOGGLE

- Switches highlighted elements or a function block on and off.
- Switches between two or more settings, e.g. items of selection lists. At the end of a list, the cursor is set on the first entry again.

MENU

Calls the menu tree.

**CLOSE**

Closes the active menu.

- If the entry mode is active, changes are cancelled.
- If settings in this menu require acknowledgement by means of an "Accept" button, a query is displayed asking whether the changes made should be cancelled.

HIDE

Minimizes the active open menu. The associated button in the "Winbar" remains visible.

REARR

Automatic rearrangement of open menus.

WINBAR

Toggles between display and blanking of the "Winbar".

2.1.5 Keypad for data entry

The keys in the data entry keypad are used to enter alphanumeric data and units.

Data entry keys are only enabled while the cursor is placed on a data input field in a dialog. Their function depends on the data type of the input field.



Keys	Description
0...9/abc	Enters the corresponding numbers (in numeric input fields) or characters (character input fields).
.	Inserts a decimal point (numeric input fields) or dot (character input fields) at the cursor position. Multiple decimal points are not allowed.
+/-	Changes the sign of a numeric parameter. In the case of an alphanumeric parameter, inserts a hyphen at the cursor position.
Unit keys	Selects a unit and thus determine the absolute value, or changes the unit, i.e. trigger a recalculation without changing the absolute value. The function depends on the time at which the UNIT key is used during parameter entry (see chapter 4.4.5, "Working with Units" , on page 96). For unit-free values, the X1 key is equivalent to ENTER. It confirms the previous entry and deactivates the input field.
_	Adds a blank in a character input field.
*... #	Enters special characters. Toggles through the available characters if the key is pressed several times in a row.
A <-> a	Toggles between uppercase and lowercase characters.
A, B, C, D, E, F	Enters hexadecimal values. The letters assigned to the keys are automatically active when an entry field with a hexadecimal value is active.

INSERT

Toggles between insert and overwrite mode (see also [chapter 4.4.4, "Entering a Value"](#), on page 94).

BACKSPACE

Deletes the last character before the cursor position or the selected character sequence.

ENTER

Pressing the rotary knob has the same effect.

- Concludes the entry of dimensionless entries. For other entries, this key can be used instead of the default unit key. The new value is accepted.
- Confirms ("OK") and closes open input windows.
- In a dialog box, selects the default or focused button.
- In a dialog box, activates the edit mode for the focused area, if available.
- In a dialog box, activates or deactivates the selected option of the focused area, if the edit mode is active.
- Calls the next menu level.

2.1.6 Rotary Knob and Navigation Keys

The rotary knob and the arrow keys are alternative control elements for data variation and navigation in the graphical user interface.



ROTARY KNOB

The rotary knob has several functions:

- Increases (clockwise direction) or decreases (counter-clockwise direction) numeric values at a defined step width in editing mode
- Moves the cursor, e.g. to a function block in the block diagram
- Scrolls within lists, tables or tree views
- Acts like the ENTER key, when it is pressed.
- Shifts the selection bar within focused areas (e.g. lists), if the edit mode is activated.

Note: Turning or pressing the rotary knob is equivalent to pressing the UP and DOWN keys or the ENTER key in the keypad.

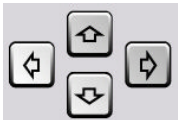

NAVIGATION KEYS

The navigation keys consist of 4 arrow keys which are used for navigation, alternatively to the rotary knob.

UP/ DOWN KEYS

The up and down arrow keys do the following:

- In a numeric edit dialog box, increase or decrease the instrument parameter.
- In a list, table, window or dialog box, scroll vertically.

LEFT/ RIGHT KEYS

The left and right arrow keys do the following:

- In an alphanumeric edit dialog box, move the cursor forward and back.
- In a list, table, window or dialog box, scroll horizontally.

2.1.7 Front Panel Connectors

I/Q input and output connectors and various additional interface connectors are located on the front panel. Connectors that are assigned to one of the two paths are marked with the appropriate letter A or B. Not particularly marked interfaces affect both paths.

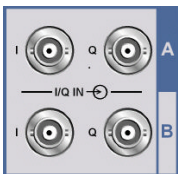

I/Q IN

I and Q inputs for external analog baseband signal (option R&S AMU-B17, Baseband Input).

For more information see:

- chapter "Data and Signal Sources in Baseband" in the Operating Manual
- chapter "Baseband Input Settings Menu" in the Operating Manual.

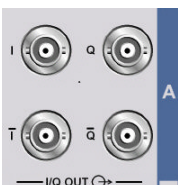

I/Q OUT A/B

Direct output or differential (non-inverting) output of the analog I/Q signal (option R&S AMU-B16, Baseband differential).

For more information see:

- chapter "Data and Signal Sources in Baseband" in the Operating Manual

- chapter "Baseband Input Settings Menu" in the Operating Manual.

**CLOCK**

Signal for Path A only.

Input for external clock signal (bit or symbol clock, multiple of symbol clock) for synchronizing the external data signal in case of multivalent modulation. The active edge can be set.

Output for clock signal (bit or symbol clock) in the internal mode.

**DATA**

Signal for Path A only.

Input for external serial data signal in case of digital modulation.

Output for serial data signal in case of digital modulation.

For more information see:

- chapter "Data and Signal Sources in Baseband" in the Operating Manual
- chapter "Baseband Input Settings Menu" in the Operating Manual.

**TRIGGER 1**

Input for triggering digital modulations, standards and ARB.

For more information see chapter "Global Trigger Clock Input Settings" in the Operating Manual.

**USB**

USB (universal serial bus) interfaces of type A (host USB).

- Connection of peripherals such as mouse or keyboard
- Connection of memory stick for file transmission
- Firmware update

Note:

Further USB interfaces are provided on the rear panel:

- 2 type A interfaces (USB 1.1 and USB 2.0)
- 1 type B interface (device USB for data transmission)

See also [chapter 2.4.1, "Connecting USB Devices"](#), on page 30.

**MARKER 1A, 2A**

Outputs 1 and 2 for triggering and control of external devices with user-definable marker signals.

The instrument provides four outputs for marker signals. Marker signals 1 to 3 are permanently assigned to the outputs; marker signal 4 can be routed to one of the four USER outputs. The assignment is as follow:

Path A

- Marker 1,2: BNC connectors MARKER 1A/2A on the front panel, or on the rear panel.
- Marker 3: MARKER 3A pin of the AUX I/O connector on the rear panel.
- Marker 4: BNC connector USER 1 or USER 2/3/4 pins of AUX I/O connector on rear panel.

Path B

- Marker 1: MARKER 1B/2B output on the rear panel.

- Marker 3: MARKER 3B pin of the AUX I/O connector on rear panel.
- Marker 4: BNC connector USER 1 or USER 2/3/4 pins of AUX I/O connector on rear panel.

For more information see section "Global Trigger/Clock/Input Settings" in the Operating Manual.

2.2 Rear Panel Tour

This section gives an overview of connectors on the rear panel of the instrument. Each connector is briefly described and a reference is given to the chapters containing detailed information. For technical data of the connectors refer to the data sheet.

If a connector of a two-path instrument is available for one path only (e.g. path A) or for either of the two (path A or B), a note is made in the brief description.



For more detailed information, refer to the corresponding description in the Operating Manual.



Fig. 2-2: Rear panel view

2.2.1 Description of the Connectors



LAN CONNECTOR

Ethernet interface

- For integrating signal generators in a network
- Remote control of signal generator
- Input of external asynchronous data

- Remote access to the signal generator
- Firmware update

See also:

- [chapter 2.6, "Setting Up a Network \(LAN\) Connection"](#), on page 34
- chapter "Remote Control Basics" in the Operating Manual

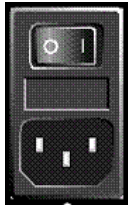

AC SUPPLY AND POWER SWITCH

When the R&S AMU is connected to the AC supply, it automatically sets itself to the correct range for the applied voltage (range: see type label). There is no need to set the voltage manually or change fuses.

The power switch can be set to two positions:

- **0**
The instrument is disconnected from the mains.
- **I**
The instrument is power-supplied. It is either ready for operation (STANDBY) or in operating mode, depending on the position of the ON/STANDBY switch on the instrument front.

See also data sheet and [chapter 2.3.3, "Connecting the Instrument to the AC Supply"](#), on page 26.

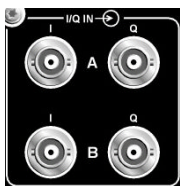

I/Q IN A/B

Input for external analog modulation signal in case of I/Q modulation (independent for path A and B).

Input for external analog baseband signal (option R&S AMU-B17, Baseband Input).

Rear panel connectors for path A and path B (option R&S AMU-B81).

This option is recommended for use of the instrument in a 19" rack. Installing the instrument in a 19" rack requires a rack adapter or an adapter for telescopic sliders (refer to data sheet for order number).

For more information see chapter "Data and Signal Sources in Baseband" and "I/Q Settings" and in the Operating Manual.

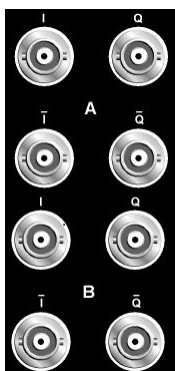

I/Q OUT, I/Q BAR OUT

(path A or path B)

Direct output or differential (non-inverting) output for analog I/Q signal. For differential output option R&S AMU-B16 is required.

For the use of the instrument in a 19" rack, we recommend that you use the connectors for path A and B on the back (option R&S AMU-B81). Installing the instrument in a 19" rack additionally requires a rack adapter or an adapter for telescopic sliders (refer to data sheet for order number.).

See also "Analog I/Q Output Settings" in the Operating Manual.

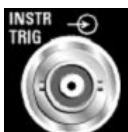

INSTR TRIG

The INSTR TRIG connectors are reserved for future extensions.

**RESERVE**

The RESERVE connector is reserved for future extensions.

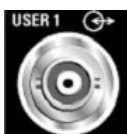
**USER**

Input/output for configurable signals for triggering and control.

The following signals can be applied to the connector:

- Marker 4
- Clock Out (bit or symbol)
- CW mode Out
- No signal (blank) marker

Note: With exception of the Clock Out signal, the signals for triggering and control apply for both paths.

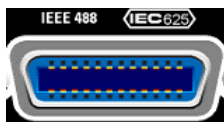
**IEC 625/IEEE 488**

IEC-bus (IEEE 488) interface for remote control of the instrument.

See also [chapter A.1, "GPIB Bus Interface"](#), on page 115 and chapter "Remote Control Basics" in the Operating Manual.

Note: In order to avoid electromagnetic interference (EMI) caused by open lines, always terminate any connected IEC-bus cable with an instrument or a controller.

**MARKER 1A/2A, 1B/2B**

Outputs 1 and 2 for triggering and control of external devices with user-definable marker signals.

The instrument provides four outputs for marker signals. Marker signals 1 to 3 are permanently assigned to the outputs; marker signal 4 can be routed to one of the four USER outputs (see "[MARKER 1A, 2A](#)" on page 18). The assignment is as follows:

Path A

- Marker 1,2: BNC connectors MARKER 1A/2A on the rear panel, or on the front panel.
- Marker 3: MARKER 3A pin of the AUX I/O connector on the rear panel.
- Marker 4: BNC connector USER 1 or USER 2/3/4 pins of AUX I/O connector on rear panel.

Path B

- Marker 1,2: MARKER 1B/2B output on the rear panel.
- Marker 3: MARKER 3B pin of the AUX I/O connector on rear panel.
- Marker 4: BNC connector USER 1 or USER 2/3/4 pins of AUX I/O connector on rear panel.

For the use of the instrument in a 19" rack, we recommend that you use the connectors for path A and B on the back (option R&S AMU-B81). Installing the instrument in a 19" rack additionally requires a rack adapter or an adapter for telescopic sliders (refer to data sheet for Order No.).

Note: MARKER 1A and 2A outputs are intended for future upgrades (option R&S AMU-B81).

For more information see section "Global Trigger/Clock/Input Settings" in the Operating Manual.

See also [chapter 2.3.2, "Placing or Mounting the Instrument"](#), on page 26.

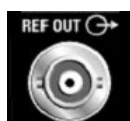
**REF OUT**

Output of internal reference signal.

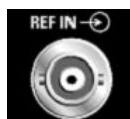
**REF IN**

Input for external reference signal.

The external reference is used for both paths.

**DATA IN/OUT**

Clock signal input/output.

Rear Panel Connectors for path A and path B (option R&S AMU-B81).

This option is recommended for use of the instrument in a 19" rack. Installing the instrument in a 19" rack requires a rack adapter or an adapter for telescopic sliders (refer to data sheet for order number).

DATA IN Input for external serial data signal in case of digital modulation (path A). The active edge can be set (path A only).

DATA OUT Output for serial data in case of digital modulation (path A).

**CLOCK OUT**

Output for internal clock signal.

This connector is used for path A only. The internal clock signal of path B can be output at one of the USER interfaces.

**CLOCK IN/OUT**

Clock signal input/output.

Rear Panel Connectors for path A and path B (option R&S AMU-B81).

This option is recommended for use of the instrument in a 19" rack. Installing the instrument in a 19" rack requires a rack adapter or an adapter for telescopic sliders (refer to data sheet for order number).

CLOCK IN Input for external clock signal (bit or symbol clock, multiple of symbol clock) for synchronizing the external data signal in case of multivalent modulation. The active edge can be set (path A only).

CLOCK OUT Output for internal (bit or symbol) clock signal (path A). The internal clock signal of path B can be output at one of the USER interfaces.

**MONITOR**

Connector for external monitor (see [chapter 2.4.2, "Connecting a Monitor"](#), on page 31).

For description of this connector, refer to [chapter A.3, "Monitor Connector \(MONITOR\)"](#), on page 118.

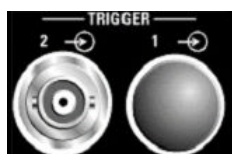
**TRIGGER 1 / 2**

TRIGGER 2: Input for external triggering of digital modulations and standards and ARB.

The trigger input is switchable to path A and/or to path B.

See also "Global Trigger Clock Input Settings".

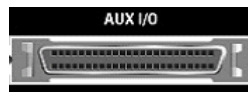
AUX I/O

Parallel input/output for data signals as well as settable trigger and control signals of the baseband. Input for device trigger.

Assignment of the AUX I/O interface and of USER pins can be configured in the "Setup > Global Trigger/Clock/External Inputs" and "Setup > USER Marker / AUX I/O Settings".

Use this dialogs to configure also the arbitrary assignment of pins to path A or B.

Note: An adapter of the AUX I/O interface to coaxial BNC connectors is available as an accessory (R&S AMU-Z5, see data sheet).

For detailed description of the AUX I/O connector, refer to [chapter A.2, "AUX I/O Connector"](#), on page 116.

**BERT**

Input for data, clock and control signals for bit and block error rate measurements, level 0.0128..1.998V.

**USB IN**

USB (universal serial bus) interface of type B (device USB).

This interface is reserved for future extensions.

Note:

Further USB interfaces are provided:

- 2 type A interfaces (master USB) on the front panel
- 2 type A interfaces (USB 1.1 and USB 2.0) on the rear

**USB CONNECTORS TYPE A**

USB (universal serial bus) interfaces of type A (host USB1.1 and USB 2.0).

- Connection of peripherals such as mouse, keyboard, etc.
- Connection of memory stick for file transmission
- Firmware update

Further USB interface type A are available on the front panel.

See also [chapter 2.4.1, "Connecting USB Devices"](#), on page 30.

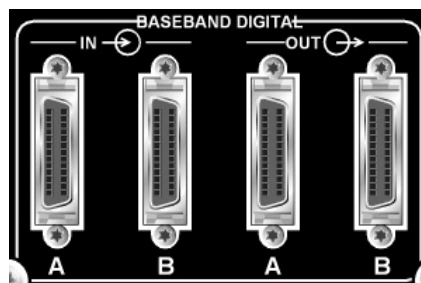
BASEBAND DIGITAL IN/OUT

Digital Interface:

- Input for external digital I/Q signal (BBIN) in case of digital modulation (option R&S AMU-B17, Baseband Input (digital/analog)).

- Output of the digital I/Q signal (BBOU) (option R&S AMU-B18 Digital I/Q Out).

Note: A further digital I/Q signal input requires a second option R&S AMU-B17, Baseband Input (digital/analog). Respectively, two-path instruments require a second option for digital I/Q output (option R&S AMU-B18, Digital I/Q Out).

Electromagnetic interference may disturb the digital data stream. Take precaution by complying with the EMC safety precautions recommended by Rohde&Schwarz (see "[Risk of electrostatic discharge](#)" on page 25).

2.3 Putting into Operation

This section describes the basic steps to be taken when setting up the R&S AMU for the first time.

WARNING

Shock hazard

Do not open the instrument casing. As a rule, normal operation of the instrument does not require opening the casing. Observe the general safety instructions and regulations at the beginning of the manual.

NOTICE

Risk of instrument damage

Note that the general safety instructions also contain information on operating conditions that will prevent damage to the instrument. The instrument's data sheet may contain additional operating conditions.

NOTICE

Risk of instrument damage

Before switching on the instrument, make sure that the following conditions are met:

- Instrument casing is closed and all fasteners are tightened.
- All fan openings are unobstructed and the airflow perforations are unimpeded. The minimum distance from the wall is 10 cm.
- The instrument is dry and shows no sign of condensation.
- The instrument is operated in the horizontal position on an even surface.
- The ambient temperature does not exceed the range specified in the data sheet.
- Signal levels at the input connectors are all within the specified ranges.
- Signal outputs are correctly connected and are not overloaded.

Failure to meet these conditions may cause damage to the instrument or other devices in the test setup.

NOTICE**Risk of electrostatic discharge**

Protect the work area against electrostatic discharge to avoid damage to electronic components in the modules. For details, refer to the safety instructions at the beginning of this manual.

**EMI impact on measurement results**

Electromagnetic interference (EMI) can affect the measurement results. To avoid any impact, make sure that the following conditions are met:

- Use suitable double-shielded cables.
- Do not use USB connecting cables exceeding 1 m in length.
- Use only USB devices that remain within the permissible EMI limits.
- Always terminate any connected IEC-bus cables with an instrument or controller.

Outputs and lines have to be terminated properly with 50 Ohms.

For digital interfaces only the cable R&S AMU-Z6 is permitted for connection. The associated cable is available under part number 1415.0201.02.

2.3.1 Unpacking and Checking the Instrument

To remove the instrument from its packaging and check the equipment for completeness proceed as follows:

1. Pull off the polyethylene protection pads from the instrument's rear feet and then carefully remove the pads from the instrument handles at the front.
2. Pull off the corrugated cardboard cover that protects the rear of the instrument.
3. Carefully unthread the corrugated cardboard cover at the front that protects the instrument handles and remove it.
4. Check the equipment for completeness using the delivery note and the accessory lists for the various items.
5. Check the instrument for any damage. If there is damage, immediately contact the carrier who delivered the instrument. Make sure not to discard the box and packing material.

**Packing material**

Retain the original packing material. If the instrument needs to be transported or shipped at a later date, you can use the material to prevent control elements and connectors from being damaged.

2.3.2 Placing or Mounting the Instrument

The R&S AMU is designed for use under laboratory conditions, either on a bench top or in a rack using a rack adapter kit (order number see data sheet).

Bench Top Operation

If the R&S AMU is operated on a bench top, the surface should be flat. The instrument can be used in horizontal position, standing on its feet, or with the support feet on the bottom extended.

⚠ CAUTION

Risk of injury

The feet may fold in if they are not folded out completely or if the instrument is shifted. Fold the feet completely in or completely out to ensure stability of the instrument and personal safety. To avoid injuries, never shift the instrument when its feet are folded out. When the instrument is standing on its folded-out feet, do not work under the instrument and do not put anything under it, otherwise injuries or material damage could occur. The feet may break if they are overloaded. The overall load on the folded-out feet must not exceed 500 N.

Rackmounting

The R&S AMU can be installed in a rack using a rack adapter kit (Order No. see data sheet). The installation instructions are part of the adapter kit.

NOTICE

Risk of instrument damage

For rack installation, make sure that all fan openings are unobstructed and that the airflow perforations are unimpeded. This helps to prevent the instrument from overheating.

2.3.3 Connecting the Instrument to the AC Supply

The R&S AMU is automatically adapted to the AC voltage supplied. There is no need to set the voltage manually or change fuses. The [AC SUPPLY AND POWER SWITCH](#) is at the rear of the unit.

- ▶ Connect the instrument to the AC power source using the AC power cable delivered with the instrument.

Note: The instrument is in compliance with safety class EN61010-1. Connect the instrument only to a socket with earthing contact.

2.3.4 Starting the Instrument



Switching off the AC power

You can leave the AC power on permanently to preserve your last instrument settings. Switching off is required only if the instrument must be completely disconnected from all power supplies.

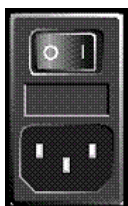

Starting up instruments with power switch

1. [Connect the instrument to the AC supply.](#)
2. To turn the power on, press the main power switch to position I (On).
After power-up, the instrument is in [standby or ready state](#), depending on the state of the ON/STANDBY key at the front panel of the instrument when the instrument was switched off for the last time.
3. In case the instrument is in standby mode, i.e. the yellow LED is on, press the ON/STANDBY key to switch the instrument to ready state.

2.3.4.1 Standby and Ready state

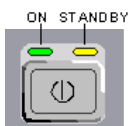

The ON/STANDBY key is located in the bottom left corner of the front panel.

Switching between standby and ready state

- ▶ Press the ON/STANDBY key briefly to switch the instrument from the standby to ready state or vice versa.

In ready state, the left, green LED is on. The instrument is ready for operation. All modules are power-supplied and the R&S AMU initiates its [startup procedure](#).
In standby state, the right, yellow LED is on. The standby power only supplies the power switch circuits and the oven-controlled crystal oscillator to keep it at its operating temperature. In this state it is safe to switch off the AC power and disconnect the instrument from the power supply.

2.3.4.2 Start Display and Booting

After power-on, the start display indicates for a few seconds the installed BIOS version and the processor characteristics.

The instrument boots the operating system, starts the instrument firmware and automatically performs a selftest. If the previous session was terminated regularly, the instrument uses the last setup with the relevant instrument settings.

Once the startup procedure has been terminated, the block diagram opened in the previous session is displayed and the instrument is ready for operation.



Use the PRESET key to return the instrument to its definite reset/preset state, if the current setup is not anymore relevant.

To customize the start settings, use the "File" dialog.



Rebooting the instrument

Press the STANDBY key for approx. 5 s. to reboot the instrument, if the software stops unexpectedly.

2.3.4.3 Function Check

The signal generator automatically monitors the main functions when the instrument is switched on and continuously during operation.

A detected fault is indicated by a "ERROR" message displayed in the info line together with a brief error description. For in-depth identification of the error, press the INFO key. In response, a description of the error(s) is displayed.

For more information, refer to section "Error Messages" in the Operating Manual.

Additionally to the automatic monitoring, the R&S AMU offers the following capabilities to ensure correct functioning:

- **Internal Adjustments**
Press the SETUP key and select "System > Internal Adjustments" to access the dialog for performing and configuring of the adjustments settings. A maximum level accuracy can be obtained, for instance.
- **Selftest**
A selftest is provided for service purposes. The selftest is a protected test procedure, which can be accessed if protection level 1 is disabled.

2.3.4.4 Default Settings

When the instrument is switched on, it is not the preset state that is active, but rather the instrument state that was set before the instrument was switched off. It is also recommended that you use the PRESET key to return the instrument to its defined preset state every time a new configuration is required or the current setup is not anymore relevant.

The R&S AMU offers a three-stage preset concept:

- **Preset of the settings belonging to a digital standard or associated with one dialog.**
Most of the dialog boxes provide a special "Set to Default" button that resets directly the settings associated to the corresponding dialog, e.g. all digital modulation settings in the "Custom Digital Mod" dialog.
These settings are identical to those which are called up using the PRESET key.
- **Preset the instrument to a predefined state**
The PRESET key calls up a defined instrument setup. All parameters and switching states are preset (also those of inactive operating modes). The default instrument settings provide a reproducible initial basis for all other settings. However, functions

that concern the integration of the instrument into a measurement setup are not changed, e.g. GPIB bus address or reference oscillator source settings.

In remote control it is possible to preset the settings of the two instrument's paths separately (see section "Preset Commands").

- Preset the instrument to its factory settings
The instrument can also be forced to load its default factory settings. To access the corresponding dialog box, press the SETUP key and select the "Factory Preset". For more information and an overview of the settings affected by the factory preset function, see section "Factory Preset" in the Operating Manual.

Overview of the Most Important Preset States

The following list gives an overview of the presets for the most important generator settings. The other presets can be found in the preset tables of the individual menus and the information accompanying the remote commands.

- "Reference frequency" = Internal; adjustment off
- "Offsets" = 0
- "Modulations State" = Off

Settings that are not affected by the PRESET key

- Reference frequency settings ("Ref Oscillator" menu)
- Power on settings ("Level/EMF" menu)
- Network settings ("Setup" menu)
- GPIB address ("Setup" menu)
- Password and settings protected by passwords ("Setup" menu)
- Start/Stop Gui Update ("Setup" menu)
- Display and keyboard settings ("Setup" menu)



User-defined instrument states can be stored and called up in the "File" dialog.

2.3.5 Shutting Down the Instrument

To shut down the R&S AMU, proceed as described below.

NOTICE**Risk of losing data**

If you switch off the running instrument using the rear panel switch or by disconnecting the power cord, the instrument loses its current settings. Furthermore, program data may be lost.

Press the ON/STANDBY key first to shut down the application properly.

1. Press the ON/STANDBY key to save the current setup, shut down the operating system and set the instrument to standby state.
The yellow LED must be on.
2. To switch off the power, press the main power switch to position 0 (Off).
None of the front-panel LEDs should be on.

2.4 Connecting External Accessories

The equivalent USB ports on the front and/or rear panel of the R&S AMU can be used to connect a variety of accessories.

In addition the instrument provides interfaces for monitor connection and network integration (see [chapter 2.4.2, "Connecting a Monitor"](#), on page 31 and [chapter 2.6.1, "Connecting the Instrument to the Network"](#), on page 34).

2.4.1 Connecting USB Devices

The USB interfaces on the front and (optionally) rear panels of the R&S AMU allow you to connect USB devices directly to the instrument. This number can be increased as necessary by using USB hubs. Due to the large number of available USB devices, there is almost no limit to the expansions that are possible with the R&S AMU.

The following list shows various USB devices that can be useful:

- Memory stick for easy transfer of data to/from a computer (e.g. firmware updates)
- CD-ROM drives for easy installation of firmware applications
- Keyboard or mouse to simplify the entry of data, comments, file names, etc.
- Printer for printing out measurement results
- Power sensors, e.g. of the NRP Zxy family

Installing USB devices is easy under Windows XP, because all USB devices are plug&play. After a device is connected to the USB interface, Windows XP automatically searches for a suitable device driver.

If Windows XP does not find a suitable driver, it will prompt you to specify a directory that contains the driver software. If the driver software is on a CD, connect a USB CD-ROM drive to the instrument before proceeding.

When a USB device is subsequently disconnected from the R&S AMU, Windows XP immediately detects the change in hardware configuration and deactivates the corresponding driver.

All USB devices can be connected to or disconnected from the instrument during operation.

Connecting a memory stick or CD-ROM drive

If installation of a memory stick or CD-ROM drive is successful, Windows XP informs you that the device is ready to use. The device is made available as a new drive ("D:") and is displayed under Windows Explorer. The name of the drive is manufacturer-dependent.

Connecting a keyboard

The keyboard is detected automatically when it is connected. The default input language is English – US.

Use the "Start > Control Panel > Keyboard" or the "Regional and Language Options" menu of Windows XP to configure the keyboard properties. To access Windows XP, press the Windows key on the external keyboard.

Connecting a mouse

The mouse is detected automatically when it is connected.

Use the "Start > Control Panel > Mouse" menu of Windows XP to configure the mouse properties. To access Windows XP, press the Windows key on the external keyboard.

Connecting a printer

When printing a file, the instrument checks whether a printer is connected and turned on and whether the appropriate printer driver is installed. If required, printer driver installation is initiated using Windows XP's "Add Printer" wizard. A printer driver needs to be installed only once.

You can load updated and improved driver versions or new drivers from an installation disk, USB memory stick or another external storage medium. If the instrument is integrated in a network, you can also install driver data stored in a network directory. Use the "Add Printer" wizard on the "Start > Settings > Printer and Faxes" menu to install the driver. To access Windows XP, press the Windows key on the external keyboard.

2.4.2 Connecting a Monitor

An external monitor with an analog interface can be connected to the MONITOR connector on the rear panel of the instrument. Per default, the external monitor connector is disabled and has to be enabled before operation.



Connecting external devices

Before connecting any external device such as a monitor, make sure that the instrument is switched off (or in standby mode). Otherwise, correct operation cannot be assured. This does not apply to USB devices.

1. **Shut down the instrument.**
None of the front-panel LEDs should be on.
2. Plug in the monitor cable to the MONITOR connector on the rear panel of the instrument.
3. **Start up the instrument.**
The green LED must be on.
The external monitor is detected.
The entire display of the instrument, containing the status bar, the block diagram and the winbar is displayed on the monitor additionally. Further settings are not required.

The MONITOR interface is described in "Appendix A: Hardware Interfaces" in the Operating Manual.

2.5 Windows Operating System

The instrument contains the Windows XP operating system which has been configured according to the instrument's features and needs. To ensure that the instrument software functions properly, certain rules must be adhered to concerning the operating system.

NOTICE

Risk of causing instrument unusability

The instrument is equipped with the Windows XP operating system. Additional software can therefore be installed on the instrument. The use and installation of additional software may impair instrument function. Thus, run only programs that Rohde & Schwarz has tested for compatibility with the instrument software.

The drivers and programs used on the instrument under Windows XP have been adapted to the instrument. Existing instrument software must always be modified using only update software released by Rohde & Schwarz.

The following program packages have been tested:

- R&S Power Viewer - virtual power meter for displaying results of the Power Sensor R&S NRP-Zxx
- Windows XP Remote Desktop
- Symantec Norton AntiVirus – Virus-protection software

In certain cases, the use of these programs can impair the performance of the instrument.

2.5.1 Virus Protection

Users must take appropriate steps to protect their instruments from infection. Beside the use of strong firewall settings and regularly scanning any removable storage device used with a R&S instrument, it is also recommended that anti-virus software be installed on

the instrument. While Rohde & Schwarz does NOT recommend running anti-virus software in the background ("on-access" mode) on Windows-based instruments, due to potentially degrading instrument performance, it does recommend running it during non-critical hours.

For details and recommendations, see the R&S White Paper "Malware Protection" available at <http://www.rohde-schwarz.com/appnote/1EF73>.

2.5.2 Service Packs and Updates

Microsoft regularly creates security updates and other patches to protect Windows-based operating systems. These are released through the Microsoft Update website and associated update server. Instruments using Windows, especially those that connect to a network, should be updated regularly.

For more details and information on configuring automatic updates see the R&S White Paper "Malware Protection" (available at <http://www.rohde-schwarz.com/appnote/1EF73>).

Changes in the system setup are only required when peripherals like keyboard or a printer are installed or if the network configuration does not comply with the default settings (see [chapter 2.6.1, "Connecting the Instrument to the Network"](#), on page 34). After the R&S AMU is started, the operating system boots and the instrument firmware is started automatically.

2.5.3 Login

Windows XP requires that users identify themselves by entering a user name and password in a login window. The instrument provides a factory-installed auto login function, i.e. login is carried out automatically in the background. The ID used for autologin has administrator rights so that printer and network installations are possible. The user name and password are set to "instrument".

2.5.4 Accessing the Start Menu

The Windows XP "Start" menu provides access to the Windows XP functionality and installed programs. To open the "Start" menu, press the Windows key or the CTRL + ESC key combination on your keyboard.

All necessary system settings can be made in the "Start > Control Panel" menu (for required settings refer to the Windows XP manual and to the hardware description).



Accessing Operating System

The operating system can only be accessed if an external keyboard and/or a mouse is connected. Windows XP provides an on-screen keyboard that can be operated using a mouse, thus enabling operation by mouse only. An external keyboard is recommended for extensive entries.

Energy saving mode

An energy saving mode is a default setting in the instrument. The hard disk switches to power-save mode if it is not accessed for 30 minutes. The energy-saving mode is exited by accessing the hard disk again.

2.6 Setting Up a Network (LAN) Connection

The R&S AMU is equipped with a network interface and can be connected to an Ethernet LAN (local area network). Provided the appropriate rights have been assigned by the network administrator and the Windows XP firewall configuration is adapted accordingly, the interface can be used, for example:

- To transfer data between a controller and the tester, e.g. in order to run a remote control program. See chapter "Remote Control"
- To access or control the measurement from a remote computer using the "Remote Desktop" application (or a similar tool)
- To connect external network devices (e.g. printers)
- To transfer data from a remote computer and back, e.g. using network folders

This section describes how to configure the LAN interface. It includes the following topics:

- [chapter 2.6.1, "Connecting the Instrument to the Network"](#), on page 34
- [chapter 2.6.2, "Assigning the IP Address"](#), on page 35



LXI

The R&S AMU complies with LXI Class C. LXI gives you direct access to the LAN settings described below.



Accessing Operating System

The operating system can only be accessed if an external keyboard and/or a mouse is connected. Windows XP provides an on-screen keyboard that can be operated using a mouse, thus enabling operation by mouse only. An external keyboard is recommended for extensive entries.

2.6.1 Connecting the Instrument to the Network

There are two methods to establish a LAN connection to the instrument:

- A non-dedicated network (Ethernet) connection from the instrument to an existing network made with an ordinary RJ-45 network cable. The instrument is assigned an IP address and can coexist with a computer and with other hosts on the same network.
- A dedicated network connection (Point-to-point connection) between the instrument and a single computer made with a (crossover) RJ-45 network cable. The computer must be equipped with a network adapter and is directly connected to the instrument.

The use of hubs, switches, or gateways is not required, however, data transfer is still performed using the TCP/IP protocol. An IP address has to be assigned to the instrument and the computer, see [chapter 2.6.2, "Assigning the IP Address"](#), on page 35.

The R&S AMU uses the IP addresses 192.168.xxx.yyy for this purposes, where xxx and yyy may take values between 1...254; the subnet mask is always 255.255.255.0.

NOTICE**Risk of network failure**

Before connecting the instrument to the network or configuring the network, consult your network administrator. Errors may affect the entire network.

- ▶ To establish a non-dedicated network connection, connect a commercial RJ-45 cable to one of the LAN ports.
To establish a dedicated connection, connect a (crossover) RJ-45 cable between the instrument and a single PC.

If the instrument is connected to the LAN, Windows XP automatically detects the network connection and activates the required drivers.

The network card can be operated with a 10 Mbps Ethernet IEEE 802.3 or a 100 Mbps Ethernet IEEE 802.3u interface.

2.6.2 Assigning the IP Address

Depending on the network capacities, the TCP/IP address information for the instrument can be obtained in different ways.

- If the network supports dynamic TCP/IP configuration using the Dynamic Host Configuration Protocol (DHCP), all address information can be assigned automatically.
- If the network does not support DHCP, or if the instrument is set to use alternate TCP/IP configuration, the addresses must be set manually.

By default, the instrument is configured to use dynamic TCP/IP configuration and obtain all address information automatically. This means that it is safe to establish a physical connection to the LAN without any previous instrument configuration.

NOTICE**Risk of network errors**

Connection errors can affect the entire network. If your network does not support DHCP, or if you choose to disable dynamic TCP/IP configuration, you must assign valid address information before connecting the instrument to the LAN. Contact your network administrator to obtain a valid IP address.

Assigning the IP address manually

1. Obtain the IP address and subnet mask for the R&S AMU and the IP address for the local default gateway from your network administrator. If necessary, also obtain the name of your DNS domain and the IP addresses of the DNS and WINS servers on your network. If you use more than one LAN connector, you need separate address information for each connector.
2. Press the "Windows" key to access the operating system.
3. Open the "Control Panel" by selecting "Start > Settings > Control Panel".
4. Select "Network Connections".
5. Right-click "Local Area Connection" and select "Properties" from the context-sensitive menu, or click "Local Area Connection" and then "File > Properties".
6. On the "General" tab, click "Internet Protocol (TCP/IP)" and then select "Properties".
7. Select "Use the following IP address" and enter the address information as obtained from the network administrator.
8. If necessary, you can also select "Use the following DNS server addresses" and enter your own DNS addresses.

For more information refer to the Windows XP Help.

2.6.3 Using computer names

Alternatively to the IP address, each PC or instrument connected in a LAN can be accessed via an unambiguous computer name. Each instrument is delivered with an assigned computer name, but this name can be changed.

Querying and changing a computer name

1. Press the "Windows" key to access the operating system.
2. Select "Start > My Computer > Properties > Computer Name".
The computer name is displayed under "Full Computer Name".
3. To change the computer name, select "Change", enter the new computer name and confirm the entry.

2.6.4 Changing the Windows Firewall Settings

A firewall protects an instrument by preventing unauthorized users from gaining access to it through a network. Rohde & Schwarz highly recommends the use of the firewall on your instrument. R&S instruments are shipped with the Windows firewall enabled and preconfigured in such a way that all ports and connections for remote control are enabled. For more details on firewall configuration see the R&S White Paper "Malware Protection"

(available at http://www2.rohde-schwarz.com/file_13784/1EF73_0E.pdf) and the Windows XP help system.

Note that changing firewall settings requires administrator rights.



To transfer waveform files generated on an external PC using R&S WinIQSIM2, you have to disable the firewall.

NOTICE

Risk of Unauthorized Access

Disabling the firewall or allowing exceptions may make your instrument more vulnerable to viruses and intruders.

It is recommended that you restore the default firewall configuration after completing a task which requires modified settings.

2.6.5 Working with Directories

Access to network drives depends on access rights and whether the drives in question have been enabled. The complete integration of the R&S Signal Generator into a larger network with the necessary allocation of rights is highly complex and normally performed by a network administrator.

However, the hard disk of a computer also connected to the network can be accessed from the instrument relatively easily. The only precondition is that the directory on the remote computer that the instrument should access is enabled for remote access. Subsequently, this directory is accessed from the instrument using a Windows XP search function. This procedure is also of importance for a point-to-point connection, for instance in order to start a firmware update for which the files have been stored on the hard disk of the remote computer.



The computer and the instrument must both be provided with a computer name and an IP address (see [chapter 2.6.2, "Assigning the IP Address"](#), on page 35).

Enabling directories on the remote computer



The menu name may deviate from the name specified in the operating sequence, depending on the language and on the operating system used on the computer.

1. On the remote computer, in Windows Explorer, click the directory to be enabled.
2. From the context menu, select "Properties".
3. Select the "Sharing" tab and enable "Share this folder".

Accessing the enabled directory

1. On the instrument, select "Start > Search > For Files and Folders > Printers, Computers > A Computer in the Network".
2. Enter the computer name and press ENTER to start the search.
The computer and its name appears in the results list.
3. Click the computer's name to display the enabled directory.

Note: If a user name and password are requested when you click the computer, the login name and password used on the computer must be entered.

The files in this directory can be accessed by the instrument.

2.7 Remote Access via an External Controller

The R&S AMU can be remote accessed from a remote computer (external controller) via a network link. This allows convenient operation of the instrument from the desktop although the instrument is integrated in a rack somewhere else.



For an overview of the instrument's operating concept and the different ways to control and operate the instrument, see [chapter 3.1, "Brief Introduction to the Instrument's Concept"](#), on page 57.

There are different ways to establish a remote access connection to the signal generator but all of them require an established LAN connection between the instrument and the remote computer. The simplest way to remote access the instrument is to use a Web browser, such as Windows Internet Explorer or Mozilla Firefox for instance. Alternatively a remote access via a special application can be used.

Two free-of-charge programs are available for setting up the remote access connection: the Windows application Remote Desktop for PCs with Window operating system and the program Ultr@VNC for PCs with Linux/Unix or Windows operating system. Using of each of this two applications requires additional installation.

See the following table for an overview of the different ways to establish a remote access connection to the signal generator.

Table 2-1: Remote access via an external computer

Remote access via	LAN connection	Installation of the additional application	
		on the instrument	on the remote computer
Web Browser e.g. Windows Internet Explorer or Mozilla Firefox see chapter 2.7.1, "Using a Web Browser for Remote Access" , on page 40	required	no	no
Remote Desktop Windows application for PCs with Windows operating system see chapter 2.7.2, "Remote Desktop Connection" , on page 40	required	no	required
Ultr@VNC for PCs with Linux/Unix or Windows operating system see chapter 2.7.3, "Remote Access via Ultr@VNC" , on page 43	required	required	VNC Viewer required

When the connection is set up with Remote Desktop, the device firmware of the signal generator is disabled. Direct control on the instrument is not possible while manual remote-control is active. The access of an external PC is indicated by the logon screen of Windows XP Embedded which identifies the accessing user.

When the connection is set up with Ultr@VNC, direct control on the instrument is possible while remote access is established.

For return to direct operation on the instrument, the connection must be cut. After cutting the connection, it is still enabled and can be established again any time. The connection is disabled only after deactivation of the program.

This section gives an information on how to use the Web browser for remote access, how to install the applications for remote access and how to establish the connection between the instrument and an external computer with Windows operating system. Remote access via an external computer with Linux/Unix operating system is performed accordingly.



Accessing Operating System

The operating system can only be accessed if an external keyboard and/or a mouse is connected. Windows XP provides an on-screen keyboard that can be operated using a mouse, thus enabling operation by mouse only. An external keyboard is recommended for extensive entries.



Default password

Remote-access and file access require the user "instrument" with default password "instrument".

2.7.1 Using a Web Browser for Remote Access

The instrument can be remote-accessed via any Web browser, like Windows Internet Explorer or Mozilla Firefox for instance.

To remote access the instrument via Web browser:

1. Connect the instrument and the remote computer to a LAN, see [chapter 2.6.1, "Connecting the Instrument to the Network"](#), on page 34.
2. Instal the Java Runtime Environment JRE on the remote computer.
3. Type the instruments' IP address in the address field of the Web browser on your PC, e.g. *http://10.111.11.1*

The "VNC Authentication" screen appears.

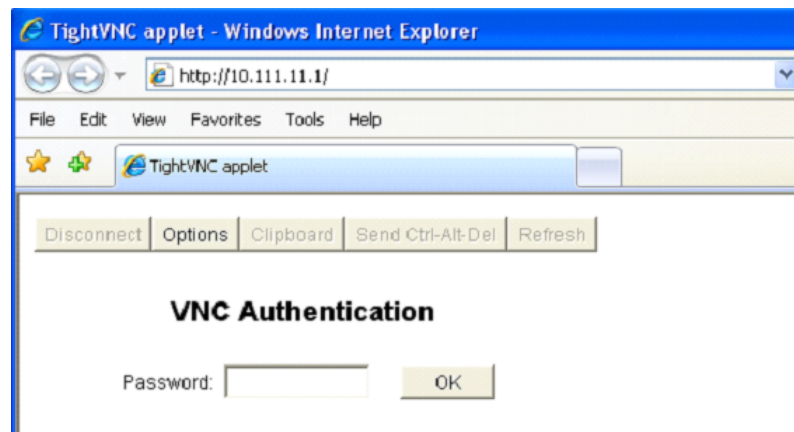

4. Enter the password and select "OK".
The default password is "instrument".

After the connection is established, the current signal generator screen with the block diagram is displayed and the instrument can be remote-accessed from the remote computer.

2.7.2 Remote Desktop Connection

Remote Desktop is a Windows application which can be used to access and control the instrument from a remote computer through a LAN connection. While the instrument is in operation, the instrument screen contents are displayed on the remote computer, and Remote Desktop provides access to all of the applications, files, and network resources of the instrument. Thus, remote operation of the instrument is possible.

NOTICE**Risk of Unauthorized Access**

If the Windows Remote Desktop application is enabled on the instrument (go to "Start > Settings > Control Panel > System"), any user in the network who knows the computer name and login data can access it. To prevent this, make sure that the Remote Desktop application on the instrument is disabled.

To set up a Remote Desktop connection

1. Enable remote desktop control on the instrument.
2. Connect the instrument and the remote computer to a LAN, see [chapter 2.6.1, "Connecting the Instrument to the Network"](#), on page 34.
3. Set up the Remote Desktop connection between the remote computer and the instrument.

**Remote Desktop Client**

With Windows XP, Remote Desktop Client is part of the operating system and can be accessed via "Start > Programs > Accessories > [Communications >] Remote Desktop Connection."

For other versions of Windows, Microsoft offers the Remote Desktop Client as an add-on.

Enabling remote desktop control on the instrument

1. Press the "Windows" key to access the operating system.
2. Open the Control Panel by selecting "Start > Settings > Control Panel".
3. Select "System" and switch to the "Remote" tab.
4. Under "Remote Desktop", activate the "Allow users to connect remotely to this computer" option.

Note: Remote Desktop access and firewall settings.

When you enable or disable the Windows Remote Desktop option (in the "System Properties"), the associated firewall settings are adapted automatically.

5. If necessary, click "Select Remote Users" and select users who are to be given access to the R&S AMU via Remote Desktop. The user account under which configuration is carried out is automatically enabled for Remote Desktop.

Setting up the Remote Desktop connection on the remote computer

1. On the remote computer, select "Start > Programs > Accessories > [Communications >] Remote Desktop Connection."
2. Enter the instrument's name or IP address in the dialog box (see also [chapter 2.6.2, "Assigning the IP Address"](#), on page 35).

3. Enter the user ID and password for the instrument (see also [chapter 2.5, "Windows Operating System"](#), on page 32).
4. Click "Connect".

When the connection has been set up, the instrument's screen appears on the remote computer.



Disabled Direct Control

While remote access is active, the direct control of the instrument is disabled.

Remote access is indicated on the instrument by the logon screen of the operating system. The logon screen identifies the accessing user.

For simultaneous remote access of several instruments from the same PC, a separate Remote Desktop session must be opened for each instrument.

For detailed information about Remote Desktop and the connection refer to the Windows XP Help.

Helpful settings for Remote Desktop

The following settings for the Remote Desktop connection can make working on the remote PC more convenient.

1. When setting up the connection to the instrument, you can configure the connection settings in the "Remote Desktop Connection" dialog box.
Click the "Options >>" button.
The dialog box is expanded to display the configuration data.
2. Customize the settings:
 - **On the "Experience" tab:**
 - Select the appropriate connection to optimize the connection speed.
 - To improve the performance, you can deactivate options you do not require under "Allow the following".
 - **On the "Local Resources" tab:**
 - If you need to access drives of the remote PC from the instrument (e.g. in order to store settings or to copy files from the PC to the instrument), activate the "Disk drives" option. Windows XP will then map drives of the remote PC to the corresponding network drives. When a connection is established, a warning is displayed on the PC indicating that the drives are enabled for access from the instrument.
 - To use printers connected to the remote PC while accessing them from the instrument, activate the "Printers" options. Do not change the remaining settings.
 - **On the "Display" tab:**
 - Under "Remote desktop size", set the size of the R&S AMU window on the desktop of the remote PC.
 - Activate the "Display the connection bar when in full screen mode" option.

A bar showing the network address of the instrument is displayed on the screen which you can use to reduce, minimize or close the window.

- **On the "General" tab:**

You can save the connection settings for later use using the "Save As" button.

Terminating Remote Desktop Control

A Remote Desktop connection can be terminated either on the R&S AMU or on the remote PC. The connection can be established again any time as long as remote control is enabled on the instrument. Consider the notice above concerning unauthorized access due to Remote Desktop!

1. To terminate the connection on the instrument, click "Disconnect" in the remote-control message menu of the R&S AMU.
2. To terminate the connection on the remote PC, close the "Remote Desktop" window, or select "Start > Disconnect".

Disabling Remote Desktop Control

To disable the remote access, deactivate the Remote Desktop on the instrument.

- ▶ Under "Remote Desktop", disable the "Allow users to connect remotely to this computer" option and confirm with "OK".

The connection is disabled, it is no longer possible to access the instrument via Remote Desktop.

2.7.3 Remote Access via Ultr@VNC

Ultr@VNC is an application which can be used to access and control the instrument from a remote computer through a LAN connection. The program is included in operating system Linux/Unix. It is available as a free-of-charge download on the internet for operating system Window XP (<http://www.uvnc.com/download/index.html>) and on the instrument's CD-ROM.

NOTICE

Risk of Unauthorized Access

If the VNC application is enabled on the instrument, any user in the network who knows the computer name and login data can access it. To prevent this, make sure that the VNC server service on the instrument is disabled.

Setting up a VNC connection

1. Connect the instrument and the remote computer to a LAN, see [chapter 2.6.1, "Connecting the Instrument to the Network"](#), on page 34.
2. [Install the Ultr@VNC application](#) and enable it on the instrument.
3. In the ICF firewall, enable communication on the network via Ultr@VNC program.

See ["Configuring Internet Connection Firewall for VNC Connection"](#) on page 46.

4. Install the VNC Viewer on the remote computer with Windows operating system, see ["Installing the VNC Viewer on a Windows PC"](#) on page 47.
5. Set up the VNC connection between the instrument and:
 - a) the remote computer with Linux/Unix operating system, see ["Setting up the VNC connection on the Linux/Unix remote computer"](#) on page 47;
 - b) the remote computer with Windows operating system, see ["Setting up the VNC connection on the Windows remote computer"](#) on page 48.



Enabled Direct Control

The direct control of the instrument is not disabled and the instrument can be controlled from the front panel and via the remote computer alternately.

Installing the Ultr@VNC application

1. Download the program from the internet and copy it to a directory that can be accessed.
2. On the instrument, shut down firmware using the ALT+F4 key combination.
3. Double click on the setup file to start the installation.
The setup wizard leads through the installation. This description focus only on the relevant settings.
 - a) Select installation of all components.

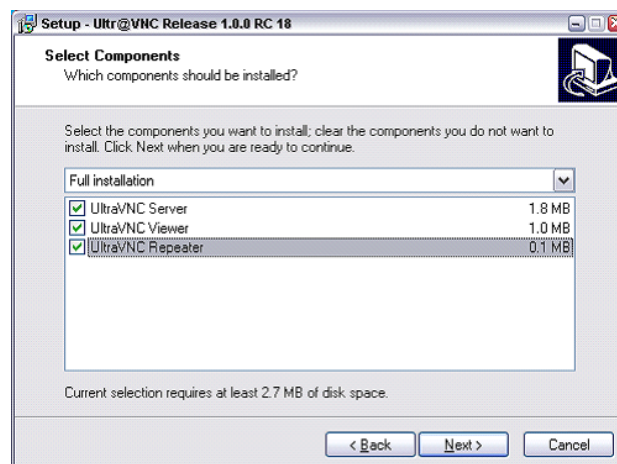

b) In the "Additional Task Panel", enable all entries.

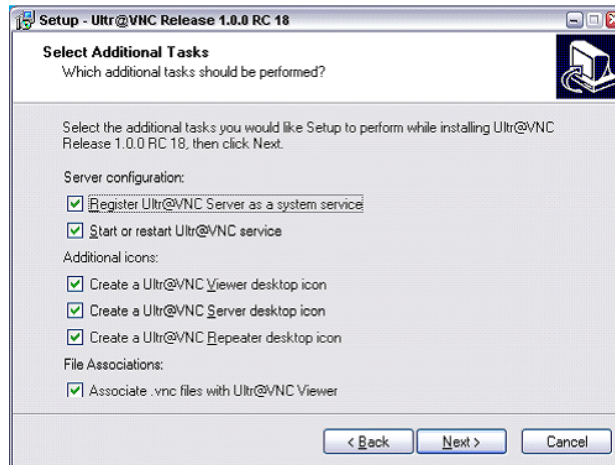

A successful installation is indicated by a message.

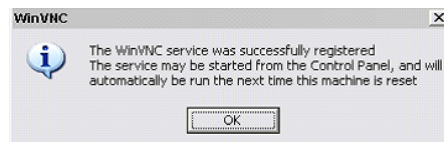

At the same time a warning is displayed stating that a password must be set.

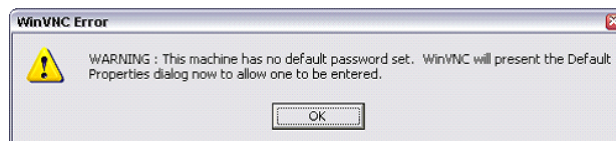

4. Select "OK".

The "Default Local System Properties" panel opens.

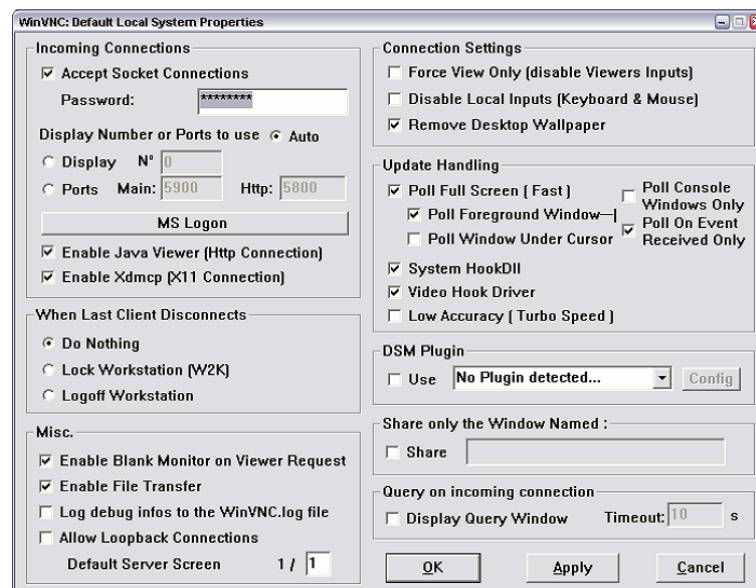

5. Enter a password with a length of at least five digits.
This password is used on the remote computer to access the instrument. Other settings may be changed according to the user-specific security requirements.

After the installation the Ultr@VNC program is automatically started together with the operating system. On mouse over, the IP address of the instrument is indicated. This IP address and the user-defined password are the prerequisites to enable remote access on the remote computer. Terminated connection is indicated by changed icon color.

Configuring Internet Connection Firewall for VNC Connection

To enable remote access of an instrument in a local network via VNC connection, the connection must be specifically permitted in the firewall.

1. Press the "Windows" key to access the operating system and select "Start > Settings > Control Panel > Windows Firewall" to open the "Windows Firewall".
2. Select "Exceptions > Add Program... > Run Ultr@VNC SERVER" and confirm with "OK".

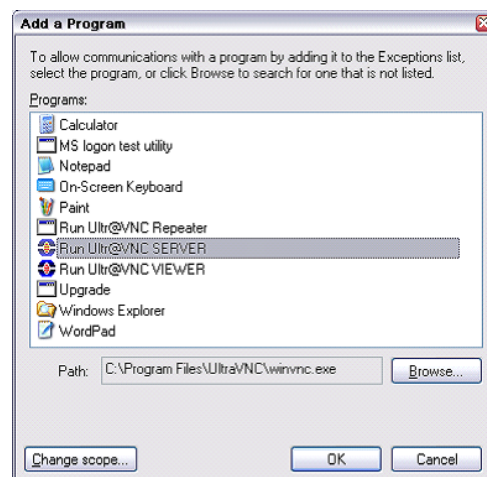

3. In the "Exceptions" tab, enable "Run Ultr@VNC SERVER".

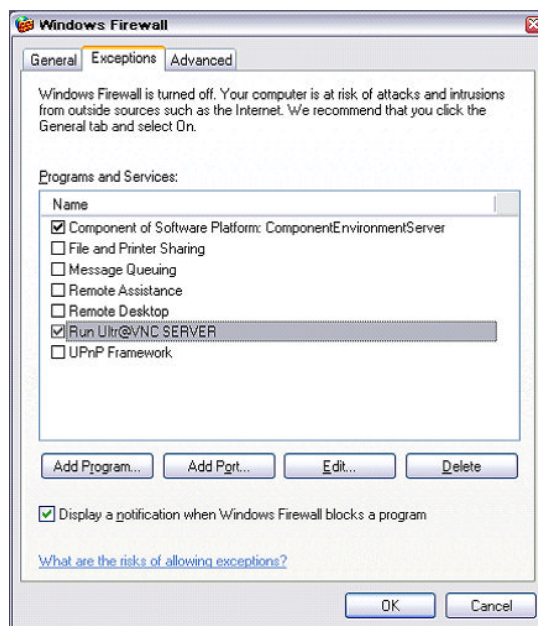

Installing the VNC Viewer on a Windows PC

1. Download the Ultr@VNC program from internet and follow the installation instructions.

Only the program component VNC Viewer is required.

Note: The VNC Viewer program is included in the download for the installation of the Ultr@VNC program on the signal generator if "Full installation" was selected in the "Select Component" panel. In this case, the program `ultr@vncviewer.exe` can be copied to the Windows PC.

2. Install VNC Viewer program component on the remote computer.

Setting up the VNC connection on the Linux/Unix remote computer

The VNC program is available per default for Linux/Unix operating systems.

1. Start a Web browser on the remote computer and enter the IP address of the instrument.
2. Enter the following address:
`vnc://<IP-address of the instrument>`, e.g. `vnc://192.168.1.1`.
A dialog is opened and the password for the remote VNC connection is requested.
3. Enter the password as defined in the "Default Local System Properties" panel of the Ultr@VNC program and select "Log On".

The connection is established, the instrument is remote accessed and the current signal generator screen with the block diagram is displayed. The individual functions are operated using the mouse and keyboard.

In contrast to remote access via Remote Desktop, the direct control of the instrument is not disabled and the instrument can be controlled from the front panel and via the remote computer alternately.

Setting up the VNC connection on the Windows remote computer

1. Start VNC Viewer program component on the PC, select "VNC Server" and enter IP address of the instrument.

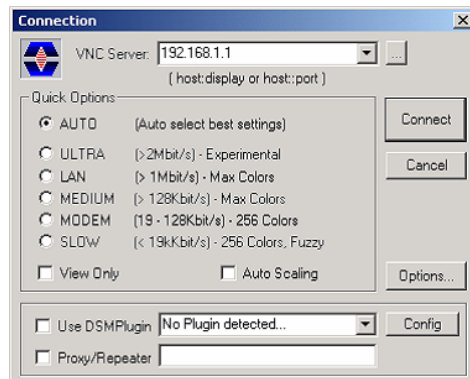

2. To initialize the connection, select "Connect".
A message requesting the password appears.

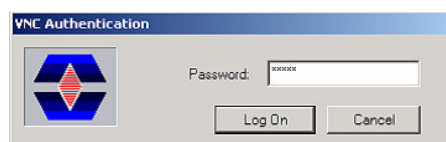

3. Enter the password as defined in the "Default Local System Properties" panel of the Ultr@VNC program and select "Log On".

The connection is established, the instrument is remote accessed and the current signal generator screen with the block diagram is displayed. The individual functions are operated using the mouse and keyboard.



Enabled Direct Control

The direct control of the instrument is not disabled and the instrument can be controlled from the front panel and via the remote computer alternately.

Terminating VNC Connection

The remote access via VNC connection can be terminated either on the R&S AMU or on the external PC. Terminating the connection does not disable it. It can be established again any time. See the notice above concerning unauthorized access due to VNC connection!

1. Terminate the connection on the R&S AMU
 - a) Press the "Windows" key to access the operating system.
 - b) Right-click on the VNC icon on the task bar and select "Kill all clients".
2. To terminate the connection on the external Linux/Unix PC, close the internet browser or close the signal generator window.

3. To terminate the connection on the external Windows PC, close the VNC Viewer program.

The connection is terminated. The color of the VNC icon in the status bar of the instrument changes.

A message on the external PC indicates the disconnection.

Disabling Remote Access via Ultr@VNC

The VNC connection can be disabled by removing the program on the instrument or by deactivating the VNC Server service.

1. Remove the VNC program
 - a) Press the "Windows" key to access the operating system and open the "Add or Remove Programs" by selecting "Start > Settings > Control Panel > Add or Remove Programs".
 - b) Remove the VNC program.
2. Deactivate the VNC Server service
 - a) Press the "Windows" key to access the operating system and open the "Services" by selecting "Start > Settings > Control Panel > Services".
 - b) Deactivate the VNC Server service.

The connection is disabled, the VNC icon disappears from the task bar of the instrument.

2.8 Using Virus-Protection Software

Virus-protection software Symantec Antivirus 10.1.7.7000 has been successfully tested for compatibility with the instrument software on R&S Signal Generator.

However, Symantec Antivirus may affect the behaviour of the instrument in terms of settling time or stability. Symantec Antivirus 10.1.7.7000 has been subjected to detailed tests with R&S Signal Generator and a page file of 1024 MB. The system remains very reliable. However, rare impact on the settling time has been experienced (slight degradations of settling time in 2% of samples out of specification).

Preparing the Installation of Symantec Antivirus

The installation is performed in the Windows XP operating system.



Accessing Operating System

The operating system can only be accessed if an external keyboard and/or a mouse is connected. Windows XP provides an on-screen keyboard that can be operated using a mouse, thus enabling operation by mouse only. An external keyboard is recommended for extensive entries.

1. Press the "Windows" key to access the operating system and open the "System" dialog by selecting "Start > Settings > Control Panel > System".

2. In the "System" dialog, select the "Advanced > Performance > Settings > Change".
3. Enable "Drive D: [DATA]" and "System managed size", confirm with "Set" and close the dialog.

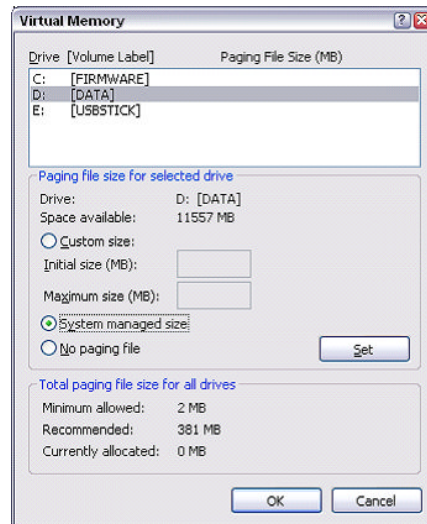

The Symantec Antivirus program can be installed.

2.9 LXI Configuration

LAN eXtensions for Instrumentation (LXI) is an instrumentation platform for measuring instruments and test systems that is based on standard Ethernet technology. LXI is intended to be the LAN-based successor to GPIB, combining the advantages of Ethernet with the simplicity and familiarity of GPIB.

Like GPIB, LXI determines and standardizes the way the instrument behaves in a LAN. The LXI implementation by the R&S Signal Generators allows you to change certain LAN settings, to reset the LAN connection as well as to easily identify the instrument.

LXI classes and LXI functionality

LXI-compliant instruments are divided into three classes, A, B and C, with the functionality of the classes hierarchically based one upon the other:

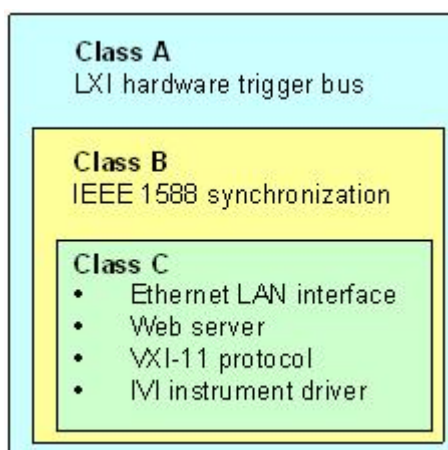

- **Class C** instruments are characterized by a common LAN implementation, including an ICMP ping responder for diagnostics. The instruments can be configured via a web browser; a LAN Configuration Initialize (LCI) mechanism resets the LAN configuration. The LXI class C instruments shall also support automatic detection in a LAN via the VXI-11 discovery protocol and programming by means of IVI drivers.
- **Class B** adds IEEE 1588 Precision Time Protocol (PTP) and peer-to-peer communication to the base class. IEEE 1588 allows all instruments on the same network to automatically synchronize to the most accurate clock available and then provide time stamps or time-based synchronization signals to all instruments with exceptional accuracy.
- **Class A** instruments are additionally equipped with the eight-channel hardware trigger bus (LVDS interface) defined in the LXI standard.



For information about the LXI standard refer to the LXI website at <http://www.lxistandard.org>. See also "News from Rohde & Schwarz, article 2006/II - 190".

Instruments of classes A and B can generate and receive software triggers via LAN messages and communicate with each other without involving the controller.

The R&S AMU complies with LXI class C and provides an integrated "LXI Status" dialog for LXI status indication and reset of the LAN configuration (LAN Configuration Initialize, LCI). To access the LXI Status dialog, press the SETUP key and select "Remote > LXI Status".

For further information, see section "LXI Status" in the Operating Manual.



Firmware update

After a firmware update, shut-down and re-start the instrument in order to enable the full LXI functionality.

Default state of the network settings

According to the LXI standard, an LCI must set the following parameters to a default state.

Parameter	Value
TCP/IP Mode	DHCP + Auto IP Address
Dynamic DNS	Enabled
ICMP Ping	Enabled
Password for LAN configuration	LxiWebIfc

The LCI for the R&S AMU also resets the following parameters:

Parameter	Value
Hostname	<Instrument-specific host name>
Description	Vector Signal Generator
Negotiation	Auto Detect
VXI-11 Discovery	Enabled

The LAN settings are configured using the instrument's "LXI Browser Interface".

2.9.1 LXI Browser Interface

The instrument's LXI browser interface works correctly with all W3C compliant browsers. Typing the instrument's host name or IP address in the address field of the browser on your PC, e.g. *http://10.113.10.203*, opens the "Instrument Home Page" (welcome page).



Do not add the missing zeros in the IP address, while opening the Instrument Home Page.

ROHDE & SCHWARZ LXI

Instrument Home Page

Instrument Properties

Instrument Model	R&S AMU 200A
Manufacturer	Rohde & Schwarz GmbH & Co. KG
Serial Number	100001
Description	Rohde & Schwarz Baseband Signal Generator and Fading Simulator AMU200A 100001
LXI Class	C
LXI Version	1.1
Host Name	10.111.11.57
MAC Address	00:E0:33:63:01:08
TCP/IP Address	10.111.11.57
Firmware Revision	02.05.108 beta (Release) (2008-04-24; 15:51:12), Compass 2.1.65.0 (Release)
Current Time	Friday, 2008/04/25, 11:25:36
Current Time source	Operating System
VISA resource string	TCP/IP::10.111.11.57::inst0::INSTR
Device Indicator	INACTIVE (press to toggle)

Status

No error

© 2008 ROHDE & SCHWARZ. All rights reserved.

The "Instrument Home Page" displays the device information required by the LXI standard including the VISA resource string in read-only format.

- ▶ Press the "Inactive (press to toggle)" button to indicate the device.

ACTIVE (press to toggle)



Pressing this button causes a LAN Status indicator on the instrument's home page to flash (if active).

A green LXI status symbol on the instrument's home page indicates that a LAN connection has been established; a red LED indicates that no LAN cable is connected. The status of the LAN connection is also indicated by the "LAN Status indicator" in the "LXI Status" dialogbox.

The "Device Indicator" setting is not password-protected.

For further information, see section "LXI Status" in the Operating Manual.

The navigation pane of the browser interface contains the following control elements:

- "LAN Configuration" opens the LAN Configuration page.
- "LXI Glossary" opens a document with a glossary of terms related to the LXI standard.
- "Status" displays information about the LXI status of the instrument.

2.9.2 LAN Configuration

The "LAN Configuration" web page displays all mandatory LAN parameters and allows their modification.

The "TCP/IP Mode" configuration field controls how the IP address for the instrument gets assigned (see also [chapter 2.6.2, "Assigning the IP Address"](#), on page 35). For the manual configuration mode, the static IP address, subnet mask, and default gateway are

used to configure the LAN. The automatic configuration mode uses DHCP server or Dynamic Link Local Addressing (Automatic IP) to obtain the instrument IP address.



Changing the LAN configuration is password-protected. The password is *LxiWebIfc* (notice upper and lower case characters). This password cannot be changed in the current firmware version.

The links at the bottom of the "LAN Configuration" page open other pages:

- "Ping Client" provides the ping utility to verify the connection between the instrument and other devices.
- "Advanced LAN Configuration" provides LAN settings that are not declared mandatory by the LXI standard.

2.9.2.1 Advanced LAN Configuration

The "Advanced LAN Configuration" menu provides LAN settings that are not declared mandatory by the LXI standard.

The "Advanced LAN Configuration" parameters are used as follows:

- The "Negotiation" configuration field provides different Ethernet speed and duplex mode settings. In general, the "Auto Detect" mode is sufficient.
- "ICMP Ping" must be enabled to use the ping utility.
- "VXI-11" is the protocol that is used to detect the instrument in the LAN. According to the standard, LXI devices must use VXI-11 to provide a detection mechanism; other additional detection mechanisms are permitted.

2.9.2.2 Ping

Ping is a utility that verifies the connection between the LXI-compliant instrument and another device. The ping command uses the ICMP echo request and echo reply packets to determine whether the LAN connection is functional. Ping is useful for diagnosing IP network or router failures. The ping utility is not password-protected.

To initiate a ping between the LXI-compliant instrument and a second connected device:

1. Enable "ICMP Ping" on the "Advanced LAN Configuration" page (enabled after an LCI).
2. Enter the IP address of the second device **without the ping command and without any further parameters** into the "Destination Address" field (e.g. *10.113.10.203*).
3. Click "Submit".

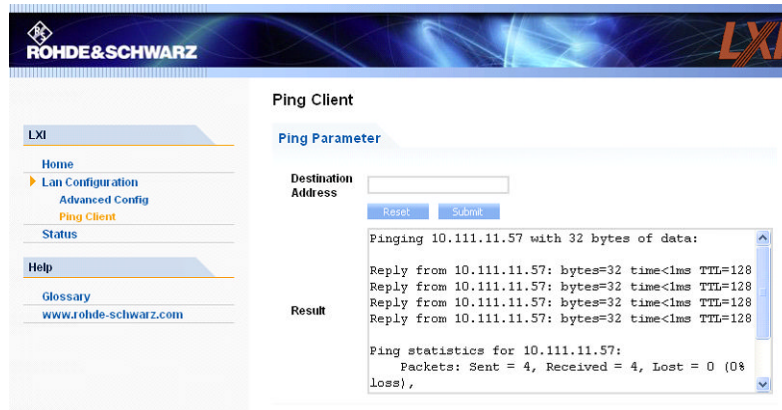

3 Getting Started

This section helps you to get familiar with the R&S AMU and provides an introduction to the general concept of the instrument with a sample of the possible application fields as well as a description of the main blocks in the signal generation flow.

This section also explains the operating concept in general and includes a brief introduction to operation by a step-by-step description of the configuration. The example is intended to provide a quick overview of the settings provided. No additional equipment is required.

3.1 Brief Introduction to the Instrument's Concept

The R&S AMU provides an entirely digital baseband section for generating I/Q signals. The R&S AMU uses internal and/or external baseband signal sources and simulates various interfering signals in the baseband, e.g. fading, noise and I/Q impairment. Digital signals can be generated internally in accordance with several digital standards or user defined signal characteristics. Analog or digital baseband signals can be fed into the signal path. The signals are generated in realtime or with the aid of the Arbitrary Waveform Generator. The digital data streams can be output directly and are converted to analog I/Q baseband output signals.



The R&S AMU may contain two paths; through the user documentation, the first being is called path A and the second path B, respectively.



The signals generated in different basebands blocks can be routed from path A to path B and vice versa and can be added. Each baseband path enables independent output of the modulated signals (analog in/out, digital in/out, analog differential out).

For a detailed description of the blocks, refer to [chapter 3.3, "Baseband Section"](#), on page 63.

The **operating concept** of the R&S AMU employs the following three ways of instrument control:

- Manual operation
- Remote control
- Remote access

Manual Operation

The R&S AMU can be entirely operated from the front panel. Peripherals such as mouse or keyboard can be connected but are not essential.

The R&S AMU is equipped with an intuitive user interface. The central element of the display is the block diagram that shows the signal flow and processing from the left on the display to most right, i.e. the generated signal can be seen at a glance.

Each block represents a functional unit of the instrument. Thus the user always knows the position at which a parameter has an effect in the signal flow. The main settings of a block are indicated in the block. The interconnection of employed inputs and outputs is also shown. The user is thus always informed about the connection of inputs and outputs in the signal flow and where they can be configured. A window is opened for each menu where parameters can be set. When the window is opened, an entry is made in the "Winbar" below the display. All open menus are of equal priority (not modal) and can be accessed any time.

The block diagram in the figure below shows a fully equipped instrument.

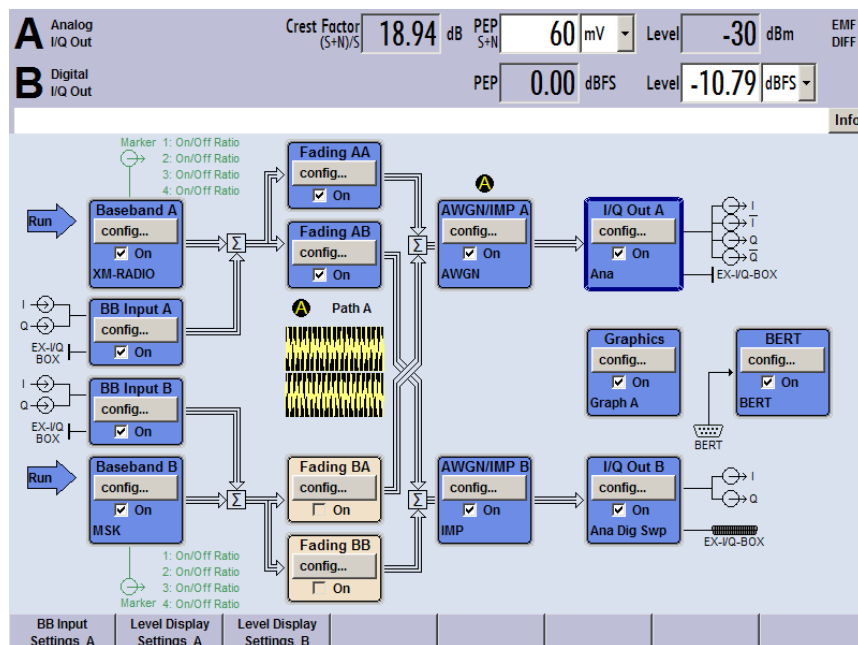

Fig. 3-1: Block diagram of a fully equipped R&S Signal Generator

With the aid of the rotary knob, the user can navigate in the block diagram and the dialogs, and can operate the instrument with one hand. The cursor is moved line by line through the block diagram or dialog. Turning the button clockwise advances the cursor. The selected block can be activated or deactivated with the TOGGLE key. Active blocks are highlighted by a colored background.

The instrument comprises a comprehensive info and help system. Context-sensitive help can be called any time with the HELP (F1) key. The help system indicates the currently selected parameter and offers additional services such as cross references, index and contents. The content of the help system corresponds to the operating manual of the instrument.

Warning and conflict messages caused by incorrect operation as well as further information are displayed in the "Info" line. A complete list of existing conflicts is displayed when the INFO (CTRL+I) key is pressed. Additional information on entries can be requested from the help system. The history function permits display of all messages.

Assistants simplify the completion of tables. After data entry in the assistant, the table is modified only after the "Accept" button has been pressed. Pressing the "Accept" button also stores the assistant data.

For an introduction into the manual operating of the instrument, detailed operating instructions and an overview of menus refer to [chapter 4, "Manual Operation"](#), on page 79.

For an indepth description of the dialog boxes and the instrument functions refer to section "Instrument Functions" in the Operating Manual.

Remote Control

Remote control is an operation of the instrument by means of remote control commands or programs that automatize repeating settings. The instrument is connected to a computer running the program.

This way of operation and the instructions how to set up a connection for remote control are described in the Operating Manual, chapter "Remote Control Basics". The description of the remote control commands is provided in the Operating Manual, chapter "Remote Control".

Remote Access

Remote access is the operating of the instrument from a remote computer. Both the R&S AMU and the computer are connected in a LAN.

Remote access in contrast to **remote control** does not use remote-control commands but a separate software which is installed on the remote computer. After its start, the software simulates the user interface of the instrument. The instrument can thus be operated from the remote computer as on the unit itself. The individual functions are operated using the mouse and keyboard. Specific instrument functions can be executed using specific key combinations on the keyboard or a front panel key emulation that can be operated with the mouse.

This way of operation and the instructions how to set up a connection for remote access are described in [chapter 2.7, "Remote Access via an External Controller"](#), on page 38.

3.2 Applications of the Instrument

The modular design of the R&S AMU allows the instrument to be equipped with two paths. This allows a multitude of applications to be performed for which several signal generators were previously required. Up to four baseband sources, two internal generators and two external inputs can be installed. A few examples are given below.

Possible applications:

- Generation of a baseband signal of different standards (realtime) or via arbitrary waveforms
- Addition of real time signals of different standards, e.g. GSM/EDGE and 3GPP FDD
- Baseband module tests with differential and digital signals
- BER Tests of baseband modules
- Design and tests of I/Q modulators
- Generation of a wanted signal and an interfering signal for tests on baseband sections of receivers

- Generation of multicarrier signals with real time components up to 80 MHz bandwidth
- Generation of fading and noise scenarios with external I/Q signals
- Signal Source for early development stage hardware simulators
- Development of new communication systems (e.g. LTE)
- Test of diversity techniques and real time baseband fading

3.2.1 Generation of Digitally Modulated Signals

The main field of application of the R&S AMU is the generation of digitally modulated signals. In the instrument, a digitally modulated signal can be generated in several ways.

Internally generated I/Q signal

The I/Q signal is generated internally in the R&S AMU. One or two baseband generators can be installed. The signals produced by the two generators can be added (possibly with frequency offset).

In this case the instrument must be equipped with

- at least one baseband generator (option R&S AMU-B9/-B10/-B11) and
- at least one baseband main module (option R&S AMU-B13).

Fading scenarios can be created with the aid of a fading module (option R&S AMU-B14, Fading Simulator) and option R&S AMU-B15, Fading Simulator Extension).

A digital/analog converter converts the internal digital baseband signals into analog I/Q output signals. The output of the analog signal can be single ended or differential (option R&S AMU-B16; Differential I/Q Output). For the digital signal output a baseband digital I/Q output (option R&S AMU-B18, Baseband Digital I/Q Output) is available.

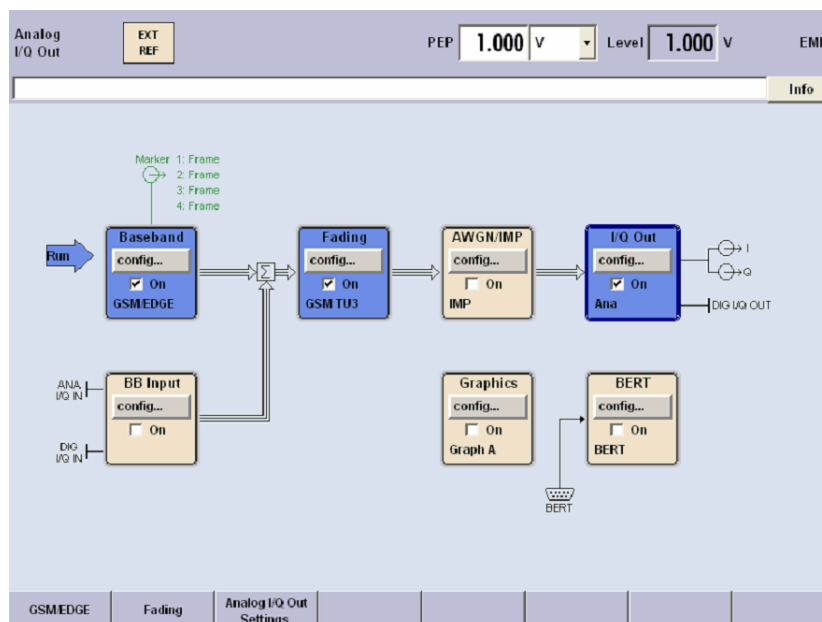

Fig. 3-2: Operation of the R&S AMU with I/Q signals generated by the internal baseband generator

Externally generated I/Q signal

The I/Q signal is generated by an external instrument and coupled in via the baseband input module (option R&S AMU-B17, Baseband I/Q Input (digital/analog)). With this baseband input module, analog or digital signals can be fed into the R&S AMU. The frequency of the signals can be shifted, and if options are installed for internal baseband generation, the external and the internal baseband signals can be added with variable level ratio. If the R&S AMU is equipped with a fading simulator (option R&S AMU-B14, Fading Simulator and option R&S AMU-B15, Fading Simulator Extension), the signals can be faded. The fading module also processes external I/Q signals.

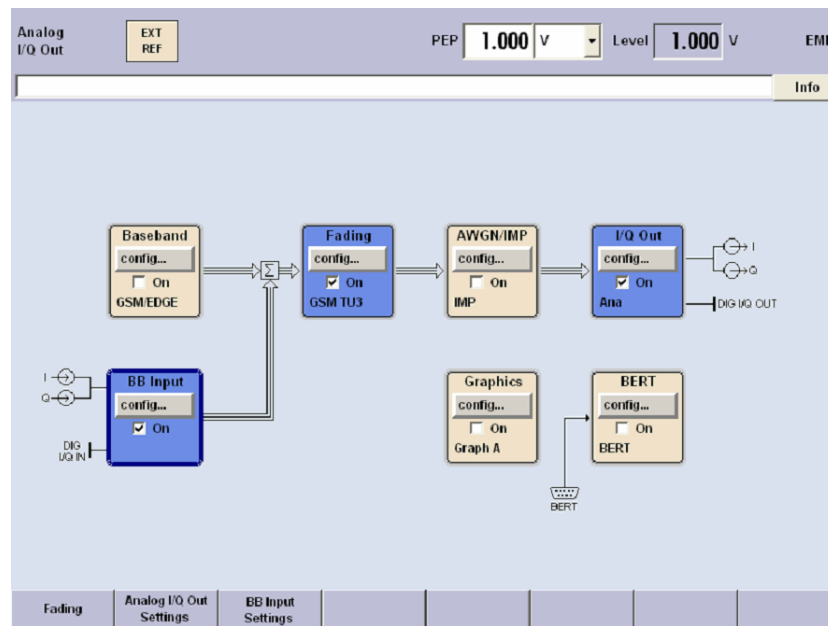

Fig. 3-3: Operation of the R&S AMU with externally applied I/Q signals.

3.2.2 One Path Instrument

A one-path R&S AMU requires at least one Baseband Main Module (option R&S AMU-B13) and a signal source. The signal source may be either the internal Baseband Generator (option R&S AMU-B9/-B10/-B11) or the external Baseband I/Q Input (option R&S AMU-B17).

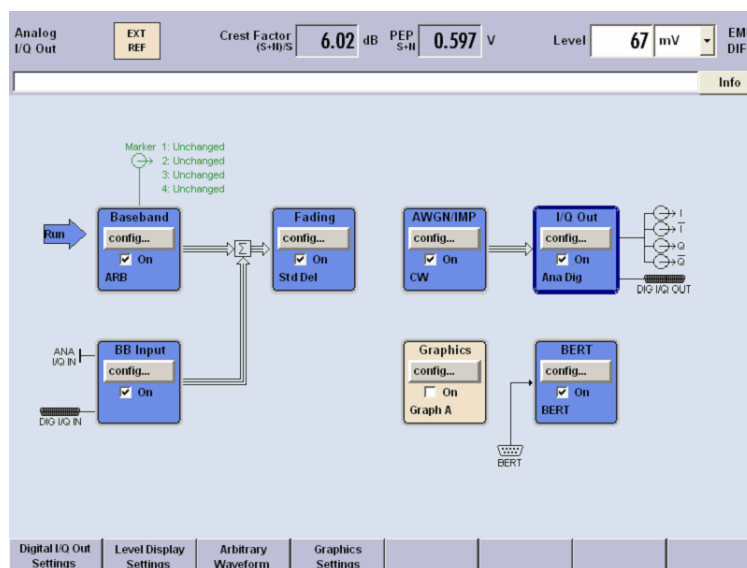

Fig. 3-4: Operation of R&S AMU with one baseband main module and two baseband sources.

Additionally the following options can be part of a one-path configuration:

- Further baseband sources (up to a configuration with two internal Baseband Generators (option R&S AMU-B9/-B10/-B11) and one external Baseband I/Q Input (option R&S AMU-B17))
- Addition of real time signals of different standards, e.g. GSM/EDGE and 3GPP FDD
- Generation of multicarrier signals with real time components
- The Fading Simulator (option R&S AMU-B14) and the Fading Simulator Extension (option R&S AMU-B15)
- Additive White Gaussian Noise AWGN (option R&S AMU-K62)
- Bit and Block Error Rate Measurement BERT (option R&S AMU-K80)
- One Differential I/Q Output (option R&S AMU-B16)
- One Digital I/Q Output (option R&S AMU-B18)



One-path instruments cannot use a second external Baseband I/Q input option.

3.2.3 Two Path Instrument

A two-path R&S AMU requires at least two Baseband Main Modules (option R&S AMU-B13) and two signal sources. The signal sources may be the internal Baseband Generators (option R&S AMU-B9/-B10/-B11) or the external Baseband I/Q Inputs (option R&S AMU-B17).

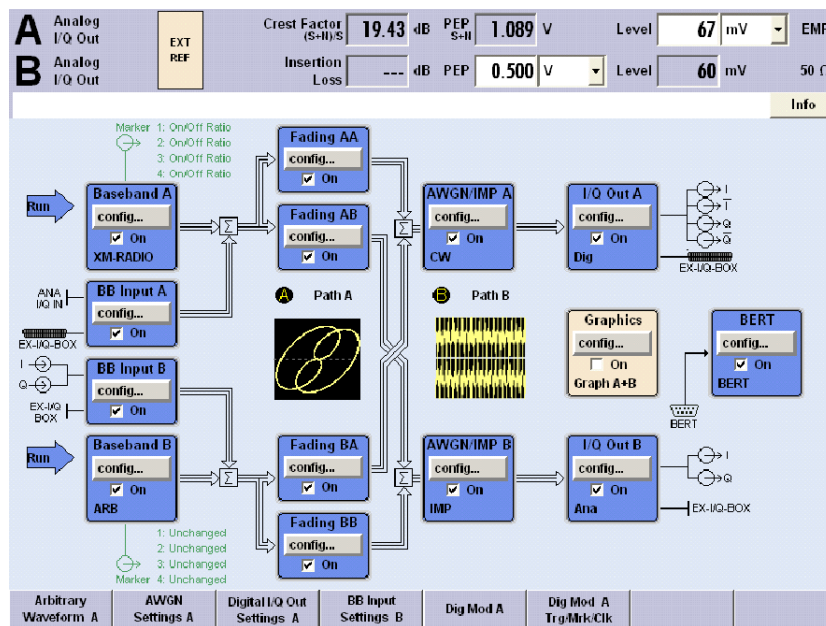

Fig. 3-5: Operation of R&S AMU as a fully equipped two-path instrument

Additionally the following options can be part of a two-path configuration:

- Further baseband sources (up to a configuration with two internal Baseband Generators (option R&S AMU-B9/-B10/-B11) and a second external Baseband I/Q Input (option R&S AMU-B17))
- Addition of real time signals of different standards, e.g. GSM/EDGE and 3GPP FDD
- Generation of multicarrier signals with real time components
- The Fading Simulator (option R&S AMU-B14) and the Fading Simulator Extension (option R&S AMU-B15)
- Additive White Gaussian Noise AWGN (option R&S AMU-K62)
- Bit and Block Error Rate Measurement BERT (option R&S AMU-K80)
- A second Differential I/Q Output (option R&S AMU-B16)
- A second Digital I/Q Output (option R&S AMU-B18)

3.3 Baseband Section

The baseband section of the R&S Signal Generator is fully digital and contains the hardware for generating and processing I/Q signals.

The baseband section may contain two paths.

For detailed information on available options, refer to the R&S AMU data sheet and the R&S AMU configuration guide.

Up-to-date information is available at R&S AMU homepage on the internet <http://www2.rohde-schwarz.com/product/amu200a.html>.

Baseband generator (option R&S AMU-B10)

The generator produces baseband signals. It contains modules for real time signal generation and an arbitrary waveform generator (ARB).

The different baseband options feature a different ARB memory size (see data sheet). But apart from the memory size, all options have the same functionality and are installed alternatively.

One or two baseband generators can be fitted in an R&S AMU and operated separately. Signals from the baseband generators can be routed from path A to B and vice versa, and added (possibly with frequency offset).

The option Baseband Generator contains real time Custom Digital Modulation and ARB. Software options providing various digital standards are offered in addition. Option R&S AMU-K40, for instance, generates signals to GSM/EDGE standard, option R&S AMU-K42 signals to 3GPP FDD standard.

Baseband input module (option R&S AMU-B17)

With the aid of this module, external analog or digital I/Q signals can be fed into the R&S AMU. For two-path instruments, an external signal can be connected to baseband path A or path B. For one-path instruments, the baseband input module is permanently linked to path A. Up to two baseband input modules can be applied. In two-path instruments the signal of the first baseband module can be routed to path A, path B or to both paths. The signal of the second baseband input module is firmly connected to path B. External and internal baseband signals can be added with variable level ratio. The I/Q signals can be further processed: e.g. the frequency of the signals can be shifted, noise can be added and they can also be faded.



The R&S AMU-B17 option can be used together with the R&S® EX-IQ-BOX digital interface module, providing a versatile digital baseband interface with various formats.

The baseband main module can be installed twice, for each of both paths A and B respectively.

The module converts the digital signal to an analog I/Q signal and routes it to the I/Q output. The analog I/Q signal can be output either single ended, or differential.

This module also offers digital I/Q impairment functions. The I/Q signal can be deliberately corrupted, e.g. for testing the receiver quality.

All frequency and time settings are coupled to the internal reference frequency.

Additional White Gaussian Noise (option R&S AMU-K62)

Additive white noise, which may be required for instance for measurements on mobile radio base stations, can be produced with the AWGN software option (R&S AMU-K62).



If the noise generator is used, a frequency offset cannot be added to the wanted signal. If two options R&S AMU-B13 are installed (paths A and B), AWGN can be generated either on path A or B with one R&S AMU-K62 option. If AWGN is to be generated on paths A and B simultaneously, two options R&S AMU-K62 must be installed.

Fading module (option R&S AMU-B14)

This module enables fading effects to be produced on baseband signals in real time. In the case of TDMA fading, up to 20 fading paths (40 fading paths with option R&S AMU-B15) can be created simultaneously.

Software option R&S AMU-B71 comprises the 3GPP dynamic fading configurations moving propagation and birth-death propagation as well as the fine delay fading configurations offering enhanced delay resolution.



At least one fading simulator, option R&S AMU-B14 must be installed. If both options R&S AMU-B14 and the R&S AMU-B15 are installed (signal path A and B), dynamic fading and enhanced resolution can be used either on signal path A or B with one option R&S AMU-K71 option. If dynamic fading and enhanced resolution is to be used on signal paths A and B simultaneously, two options R&S AMU-K71 must be installed.

Differential output module (option R&S AMU-B16)

The differential output module (option R&S AMU-B16) provides symmetrical signals for differential outputs. The operating points of the inputs can be set and balanced by an offset between inverting and non-inverting output. This module can be installed twice (for path A and path B).

Digital output module (option R&S AMU-B18)

The R&S AMU can be equipped with a standardized digital I/Q interface (LVDS) for online transfer of digital I/Q data. The digital output module (option R&S AMU-B18) enables the digital output of the I/Q baseband signal.

This module can be installed twice (for path A and path B).



The R&S AMU-B18 option can be used together with the R&S® EX-IQ-BOX digital interface module, providing a versatile digital baseband interface with various formats.

3.3.1 Description of Individual Diagram Blocks of the Baseband Section

The baseband section of the R&S AMU comprises two paths (paths A and B). Therefore, if two baseband generators are available, two baseband signals can be processed independently of each other. Routing from path A to path B and vice versa is also possible, but not after the "IMP" or "AWGN/IMP" block.



Each function block can be activated or deactivated with the "ON" check box (on/off toggling).

The ON/OFF TOGGLE key at the front panel (see "TOGGLE" on page 15) switches the currently selected block on or off.

A detailed description of the blocks is provided below.



Baseband A block

In this block, the (first) baseband source is configured and activated. The block is displayed only if a baseband generator is available in the instrument.

Depending on the installed software options, various digital standards, user-configured digital real time modulation or the built-in waveform generator (ARB) can be selected. The selected modulation is displayed in the block.

The TOGGLE ON/OFF key switches the selected modulation (digital standard, digital modulation or ARB) on or off.

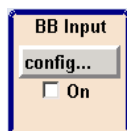

External Baseband In block

This block controls the baseband input module for external I/Q signals. The block is displayed only if the baseband input module (option R&S AMU-B17) is installed. External I/Q signals can be applied to the analog I/Q input. The output of the baseband input module can be connected to baseband path A or (if available) path B provided at least one baseband main module or one fading module is installed. Otherwise the baseband input module is permanently linked to path A. (The reason is that the baseband input module does not contain a router chip. For switchover, at least one baseband module with a router chip is required).

Note: If one baseband path is configured (path A), the external baseband signal BB Input B is connected to this path. If two baseband paths are configured the external baseband signal BB Input B is permanently routed to path B.

The TOGGLE ON/OFF key switches the input of external modulation signal on or off.



Baseband B block

Configures the second baseband source (if installed). The block is displayed only if the instrument contains two baseband generators. Depending on the installed software option, various digital standards, user-configured digital real time modulation or the built-in waveform generator (ARB) can be selected.

Note: If two baseband generators are installed and two signals of the same standard (e.g. GSM/EDGE) should be output simultaneously, the two associated software options must also be installed (in this case R&S AMU-K40).

If only one R&S AMU-K40 is installed and GSM/EDGE is selected in the first baseband generator, the second baseband generator is disabled for GSM/EDGE.

However, a software option is not tied to a specific baseband generator. In our example, either the first or the second baseband generator can output a GSM/EDGE signal.

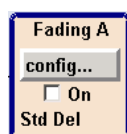

Fading block

This block controls the fading module. It is displayed only if a fading simulator (option R&S AMU-B14) is installed. Signal routing at the output of the fading module is also configured in this block.

For instance, two-channel fading can be selected if the instrument contains two baseband paths and two faders (option path extension, R&S AMU-B15).

The TOGGLE ON/OFF key switches the fading simulation on or off.

Note: Under certain signal routing conditions only one fader can be activated. At least one fading simulator, option R&S AMU-B14 must be installed. If both options R&S AMU-B14 and the R&S AMU-B15 are installed (signal path A and B), dynamic fading and enhanced resolution can be used either on signal path A or B with one option R&S AMU-K71 option. If dynamic fading and enhanced resolution is to be used on signal paths A and B simultaneously, two options R&S AMU-K71 must be installed.



AWGN/IMP A block

In this block (digital) I/Q impairments for the baseband path can be set. With the aid of the software for AWGN generation (option R&S AMU-K62), an (additive) noise signal can be produced.

AWGN and impairments can be activated independently of each other in the appropriate menus. The settings are displayed in the block. The entire block can be activated or deactivated. If the block is deactivated, the signal passes through the block unchanged. The TOGGLE ON/OFF key switches the active functions of the block on or off. The functions (AWGN, impairments or both) are activated in the respective menus.



AWGN/IMP B block

This block is displayed only if two baseband main modules (option R&S AMU-B13) are installed. In this block (digital) I/Q impairments for baseband path B can be set. With the aid of the software for AWGN generation (option R&S AMU-K62), an (additive) noise signal can be produced in path B.

If a noise signal should be applied to path A and B simultaneously, two software options R&S AMU-K62 are required.



Graphics block

With this block, the baseband signal (of path A or B) can be graphically displayed in real time. The block is displayed only if at least one baseband main module is installed.

The TOGGLE ON/OFF key opens or closes the graphics window.



BERT block

In this block an integrated bit and block error rate tester can be set. The bit error tester makes it possible to evaluate a signal demodulated and decoded by a DUT by measuring the bit error rate. The data used to drive the DUT can be generated by the R&S AMU or an user-defined external source. In addition, the block error rate measurement can be used to verify CRC checksums.

The TOGGLE ON/OFF key switches the active function(s) of the block on or off. The functions (BERT and BLER) are activated in the respective menus.

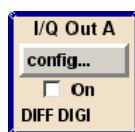

I/Q OUT A/B blocks

These blocks are used to configure the digital and analog I/Q outputs of path A. Configurations like level display, output type, analog settings and digital settings can be performed in the corresponding menus. I and Q components can also be swapped (I/Q Swap).

The status line in a block displays the currently active output types, e.g. "DIFF DIGI" denotes that the I/Q baseband signal is provided by the analog output (in differential mode) and also by the digital output.

The ON/OFF TOGGLE key switches the active function(s) of the block on or off. The functions (Analog I/Q output and Digital I/Q Output) are activated in the respective menus.

Note: The BASEBD ON/OFF key switches the baseband output signal on and off. In the two-path mode this key switches all signals off. A second stroke restores the status that was active before the last switch off.

3.4 Example of Setup

This section provides an example on how to configure the instrument for generating a fading signal in accordance with a standard GSM-TU 3 (12Path) and a carrier frequency of 904.5 MHz (virtual RF).

Configuring and displaying a GSM-TU3 signal with fading

To generate and display the GSM signal, proceed as follows:

1. Activate default (preset) state.
Press the PRESET key to set a defined instrument state.

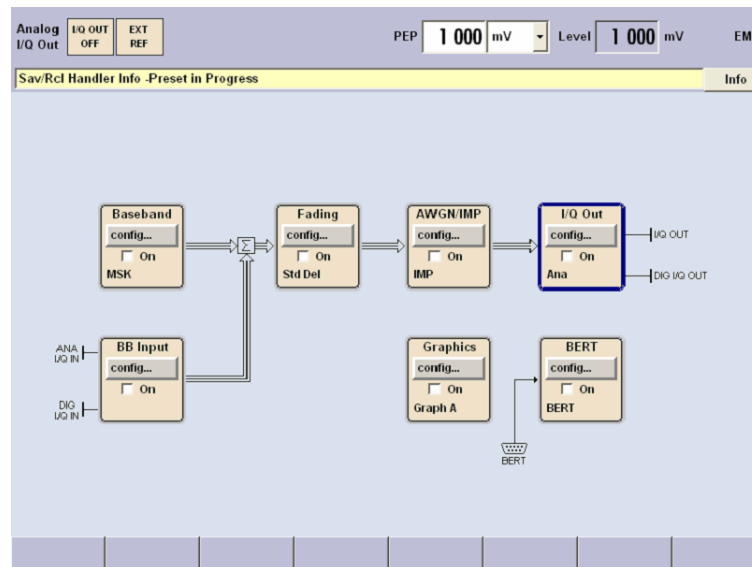

2. Select and activate the GSM/EDGE signal generation.

- a) Turn the rotary knob and select the "Baseband A" block.

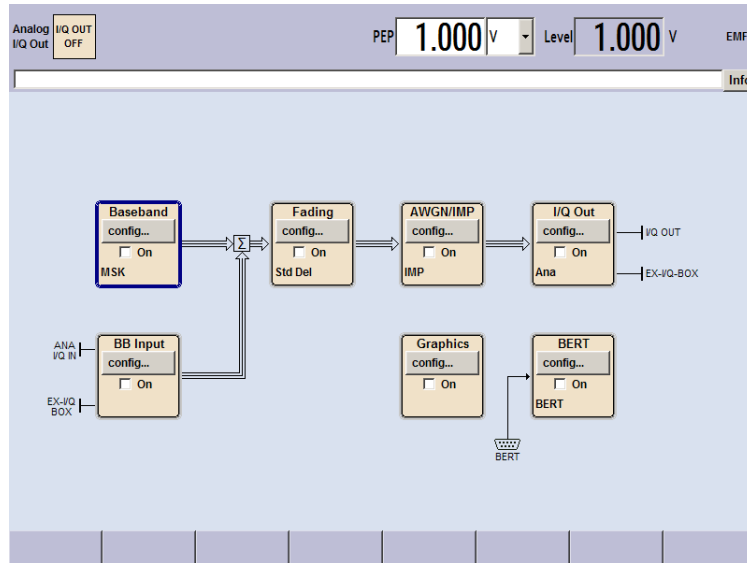

- b) Press the rotary knob to open the menu where the GSM/EDGE modulation can be selected (different modulation modes are available depending on the options installed).

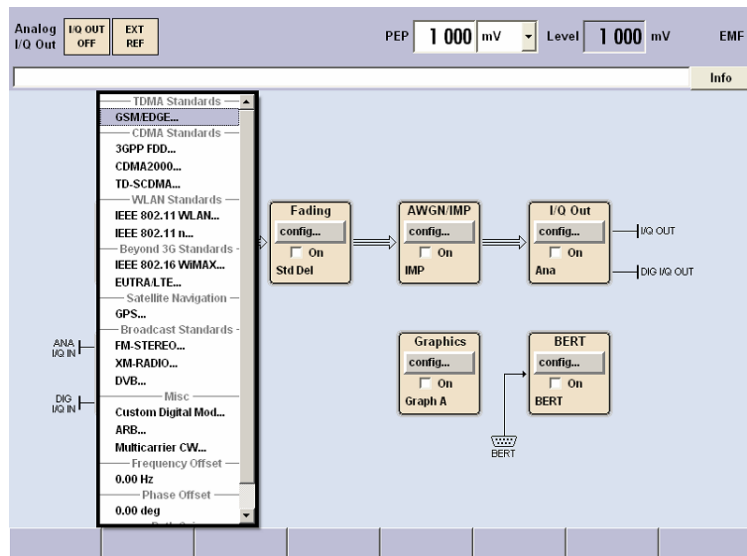

- c) Turn the rotary knob and highlight "GSM/EDGE..."

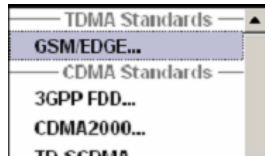

Press the rotary knob to open the "GSM/EDGE" dialog.

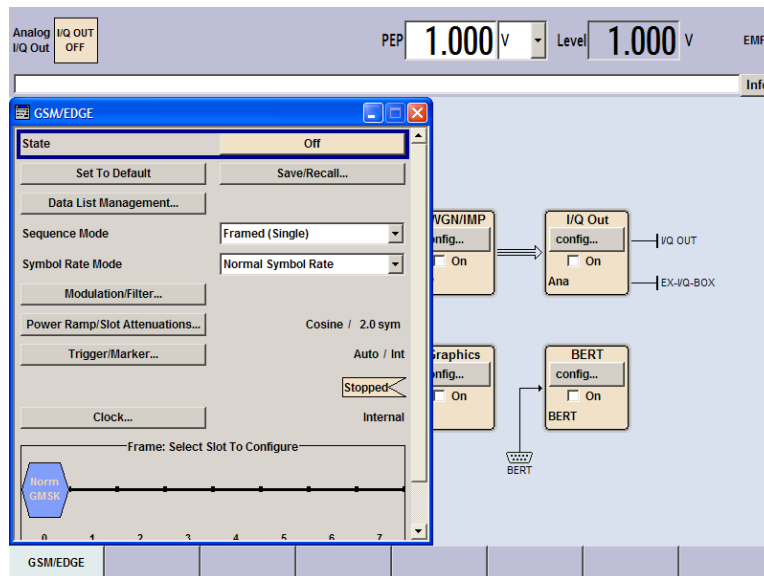

- d) Turn the rotary knob to select parameter "State", press the rotary knob to switch on GSM modulation with default settings.

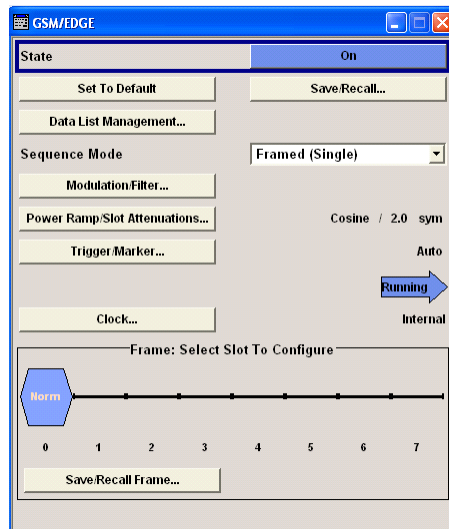

- e) Press the DIAGRAM key to display the complete block diagram.

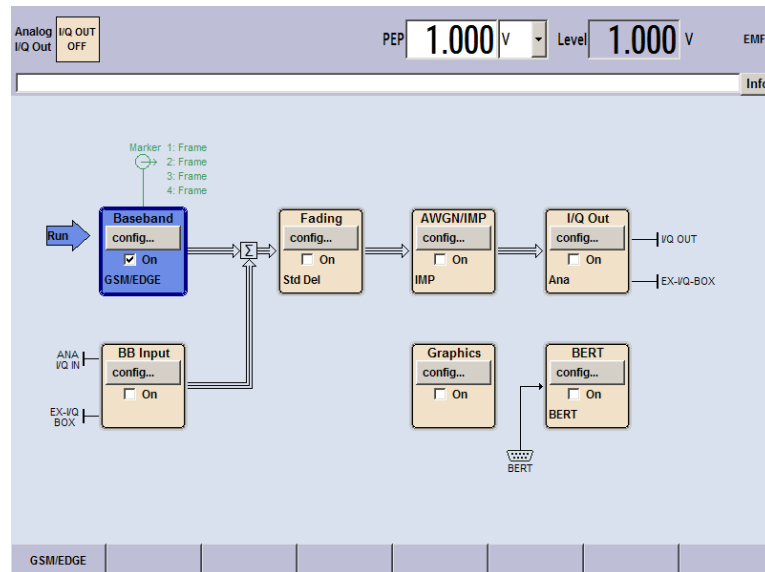

To indicate the active state, the "Baseband" block is displayed in blue and the checkbox "On" is ticked.

The entry in the Winbar indicates that the "GSM/EDGE" dialog is still open in the background.

- f) To display the dialog in the foreground, press the associated softkey below the "Winbar".

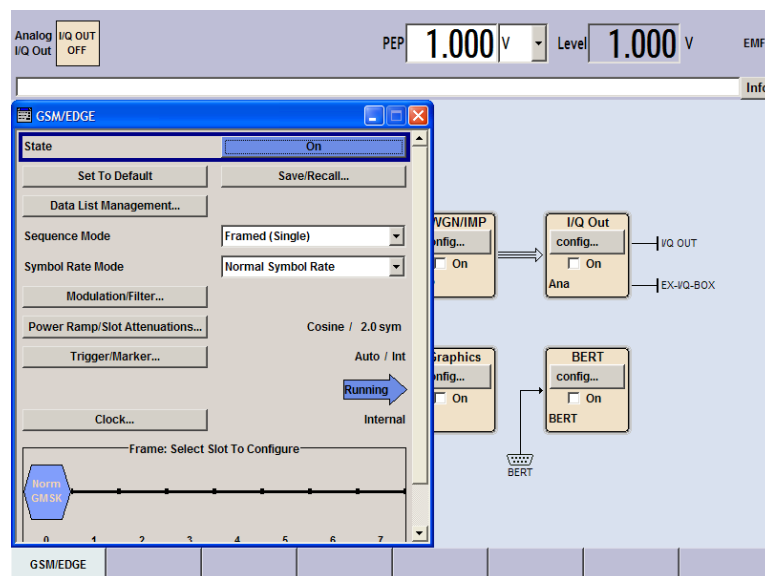

- g) Press the HIDE key to minimize the dialog again.

The "Fading", "AWGN/IMP" and "I/Q OUT" blocks are not yet active.

3. Configure and activate the fading standard GSM TU 3 (12Path).

a) Turn the rotary knob and select the "Fading" block.

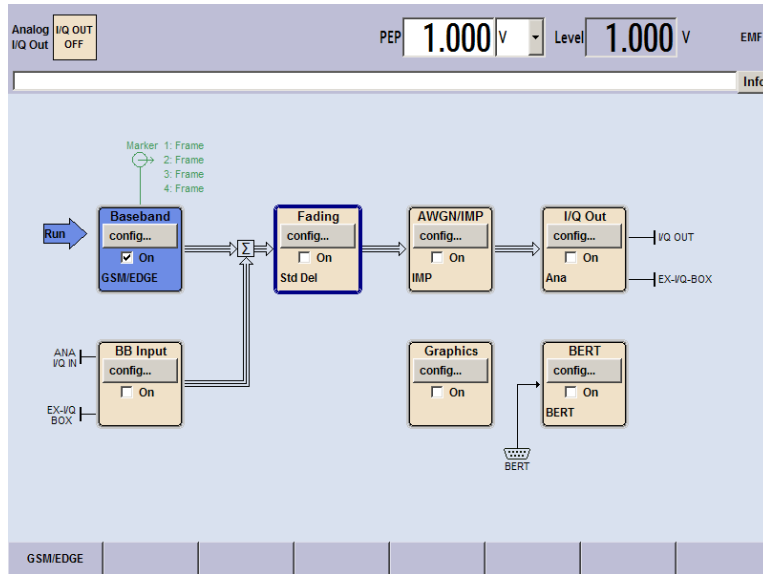

Press the rotary knob to activate the menu for fading settings.

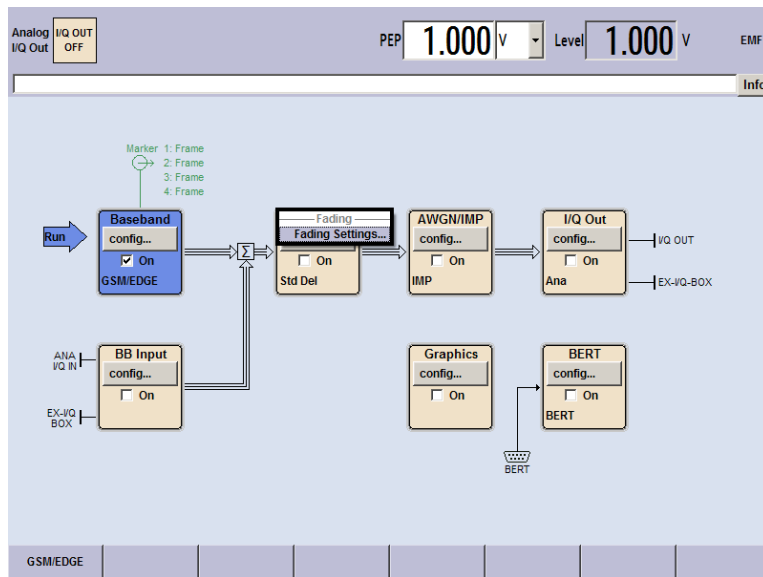

- b) Select Fading Settings, and press the rotary knob again to open the fading settings dialog.

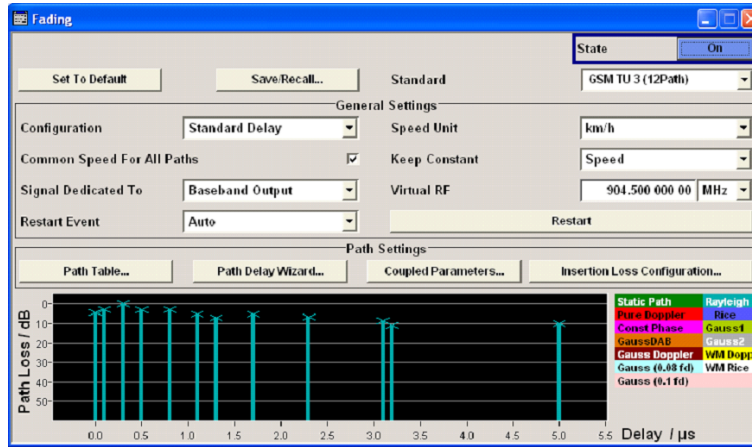

- c) Turn the rotary knob to select the Standard field.

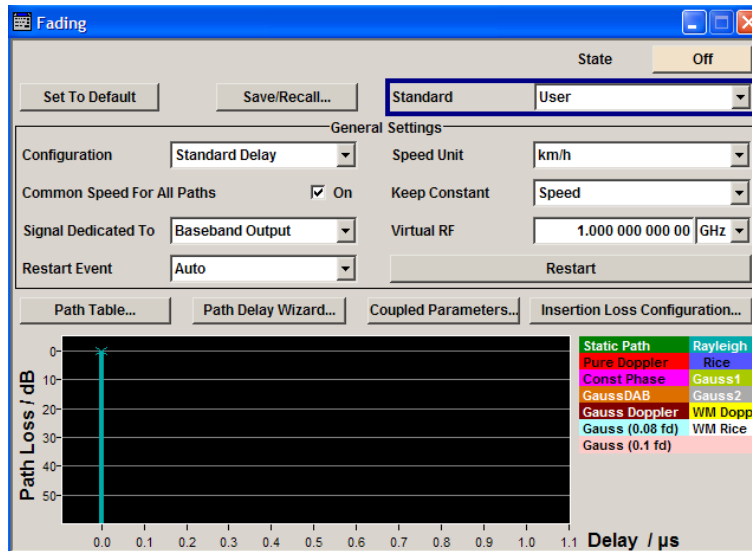

- d) Press the rotary knob to open the "Standard" selection list.

e) Select "GSM" by turning the rotary knob.

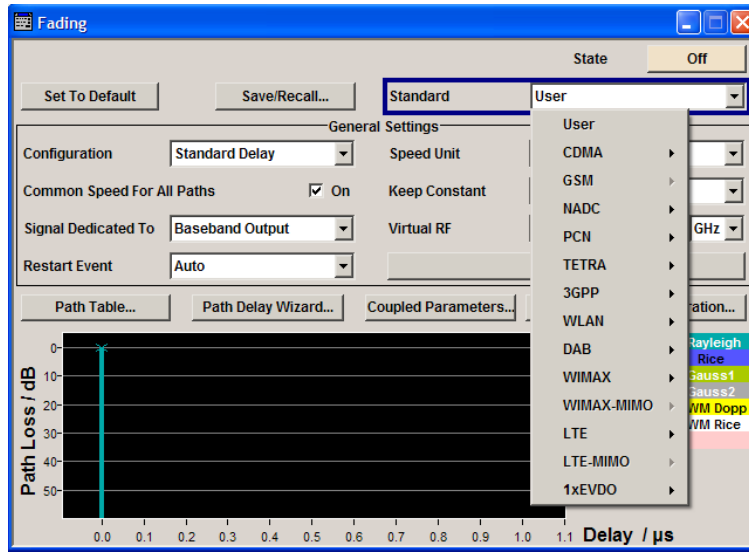

f) Open the "GSM" selection list, the select list GSM850/900 and select GSM TU 3 (12Path) in the same way.

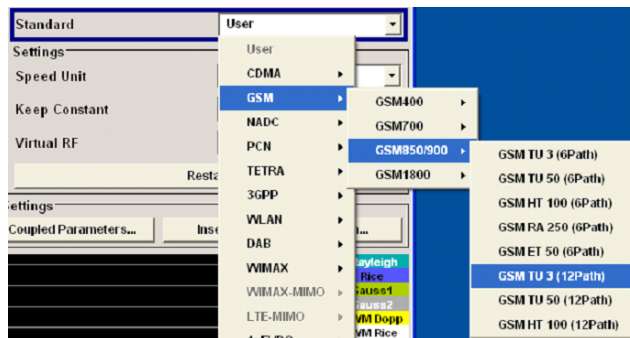

g) Press the rotary knob to confirm the selection.



The fading simulation of the standard "GSM TU 3 (12Path)" is preset.

h) Turn the rotary knob and select the Virtual RF field.

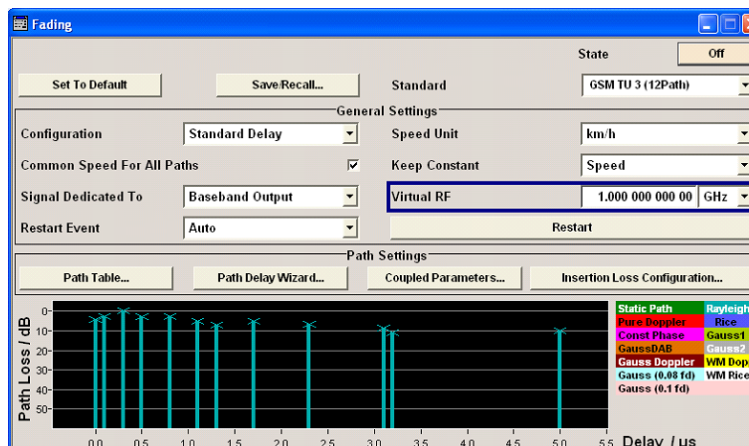

- i) Press the rotary knob to activate the editing mode.
- j) Enter the frequency value 904,5 MHz with the aid of the numeric keypad and the unit keys.



- k) Select the "State" field by turning the rotary knob.
- l) Press the rotary knob to switch on the GSM fading simulation.

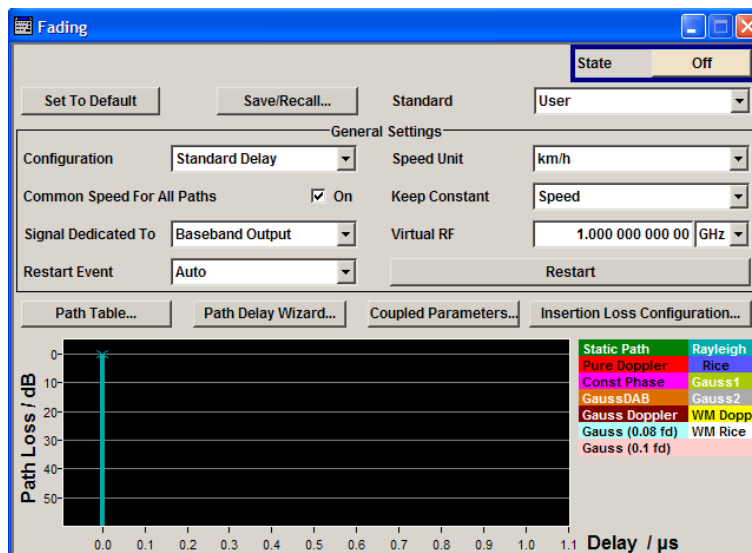

- m) Press the DIAGRAM key to display the complete block diagram.

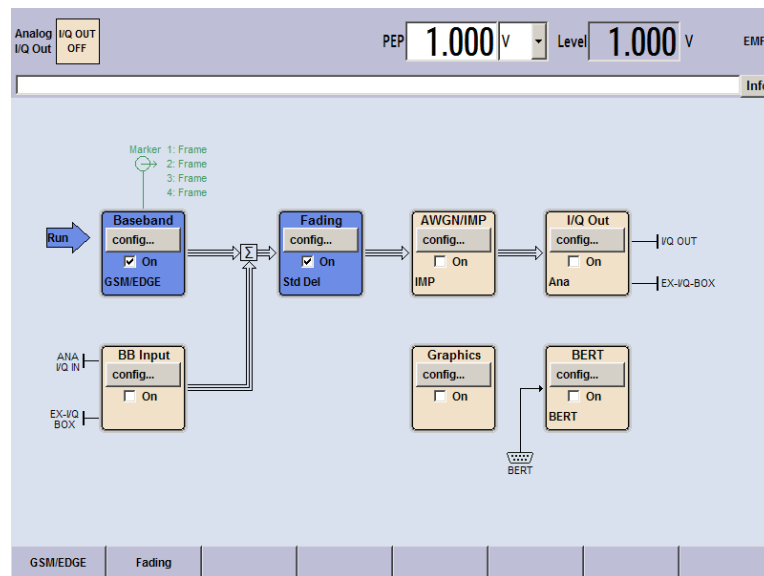

To indicate the active state, the "Fading" block is displayed in blue and the check box "On" is ticked. The "I/Q OUT" block is not yet active. The entry in the "Winbar" indicates that the "Fading" dialog is still open in the background. The dialog can be displayed in the foreground by clicking on the softkey "Fading" in the "Winbar" or by pressing the KEY below the "Fading" softkey. Press the HIDE key to minimize the dialog again.

4. Select and activate the I/Q signal output.
 - a) Turn the rotary knob to select the "I/Q Out" block.

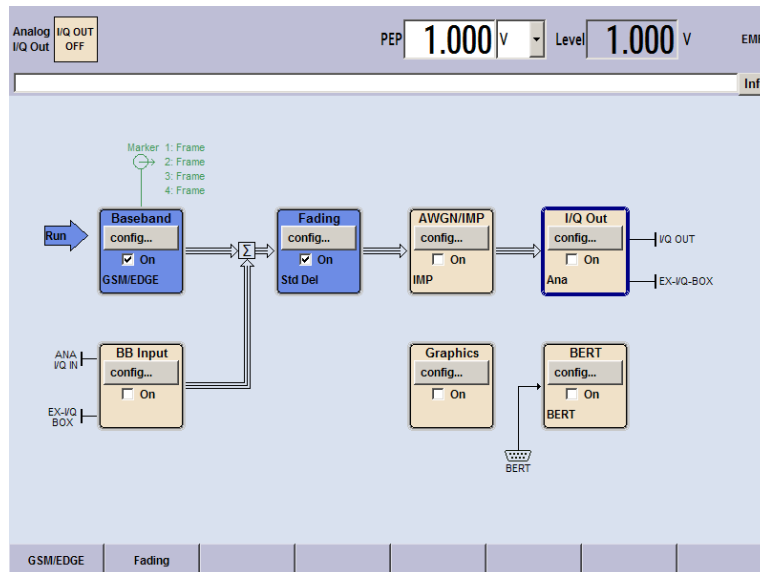

- b) Press the "config..." button to open the "I/Q Out Settings" menu.

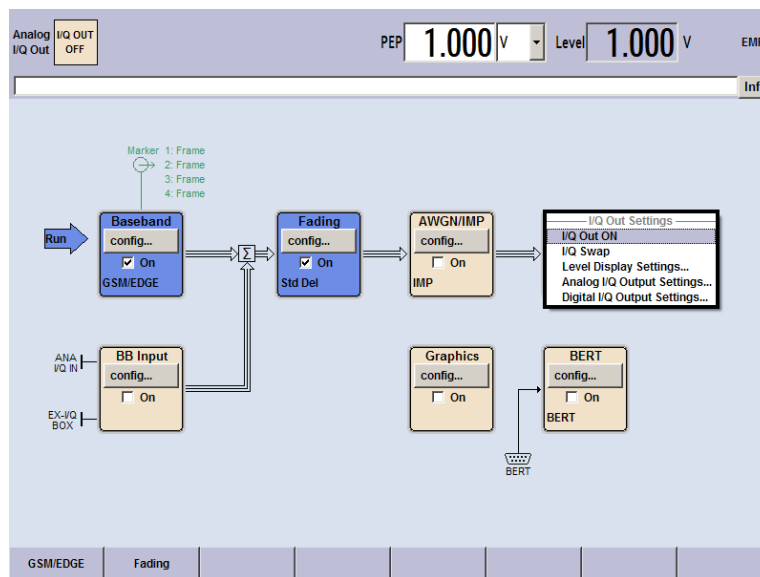

- c) Turn the rotary knob and select "Analog I/Q Output Settings".

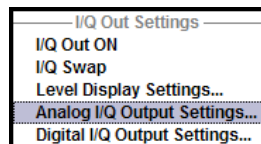

d) Press the rotary knob to open the respective dialog.

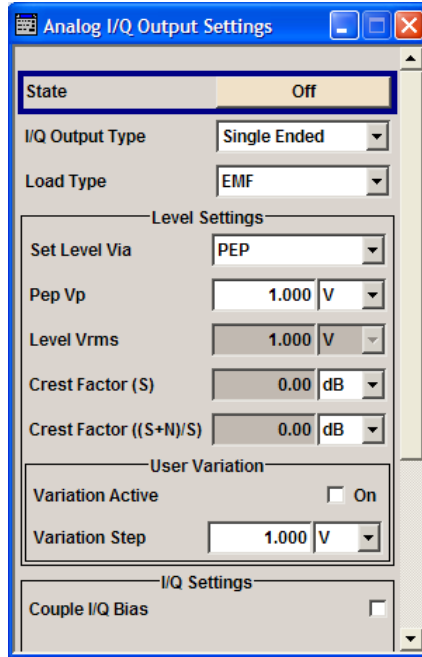

e) Switch on the analog I/Q output signal.

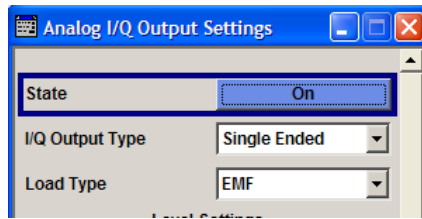

f) Press the DIAGRAM key to display the complete block diagram.

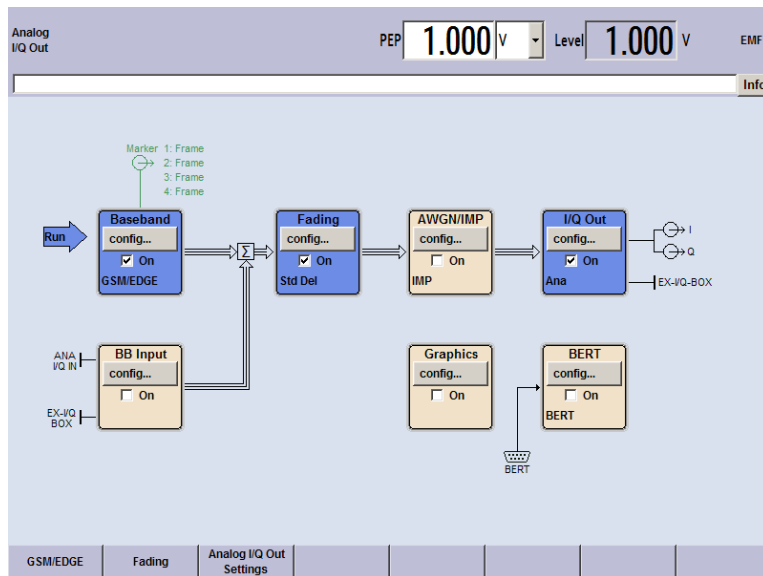

To indicate the active state, the "I/Q Out block" is displayed in blue and the check box "On" is ticked. The currently used outputs of the signal are indicated by the output symbols of the I and Q components. The entry in the Winbar indicates that the Analog I/Q Out Settings menu is still open in the background. The menu can be displayed in the foreground by clicking on the softkey "Analog I/Q Out Settings" in the Winbar or by pressing the KEY below the Analog I/Q Out Settings softkey. Press the HIDE key to minimize the menu again.

5. Select graphics display of I/Q signal.
 - a) Turn the rotary knob to select the "Graphics" block and open the respective menu.

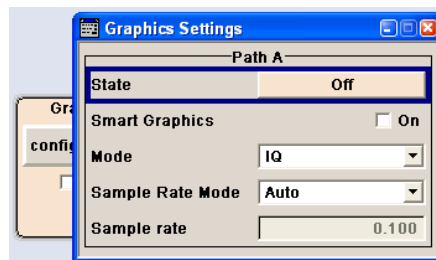

- b) Select "State On" with the rotary knob to activate display of the I/Q diagram.

The output signal is graphically displayed. It can be minimized and called the same way as dialogs.

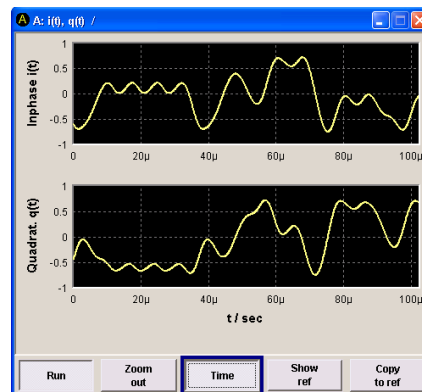

4 Manual Operation

The R&S AMU can be operated intuitively either via the interactive block diagram or via a menu tree. All menus are in the form of windows that can be operated in the same way. Rotary knob, keys and softkeys, or alternatively a mouse, allow direct and therefore convenient access to entries and settings.

The clear-cut display shows the current signal generator state. Graphs, spectra, vector diagrams, etc. can be called for a visual check of the output signal. Numerous help functions support the user in signal configuration.

This section describes the concept of manual operation of the signal generator. This includes a description of the general structure of a dialog box, working with dialog boxes and the block diagram and the setting of parameters.

For an in-depth description of the dialog boxes and the instrument functions refer to section "Instrument Functions" in the Operating Manual.

4.1 Key Features

The manual operating concept of the R&S AMU enables the user to make settings as intuitively as possible and at the same time gives a permanent overview of characteristics of the generated signal and of the current instrument state. Numerous online help functions support user settings.

Block diagram

The block diagram is the core of the operating concept.

A graphics display shows the current configuration and the signal flow in the form of a block diagram. All graphical elements can be accessed for operation. An element is selected by means of the arrow keys and the associated setting function is called by pressing Enter. Required menus and graphs are displayed on the block diagram which is displayed again in the foreground whenever the DIAGRAM (CTRL+D) key is pressed.

Permanent level display

The main characteristics of the baseband signal, PEP and level, are permanently displayed in the header section of the screen (status bar) and can be directly set in the display fields by multiple pressing the BASEBD LEVEL key (CTRL+R). Changing one of the values effects that the according value will be adjusted proportionally. Additionally, auxiliary information on the parameters insertion loss or crest factor are displayed for the corresponding paths.

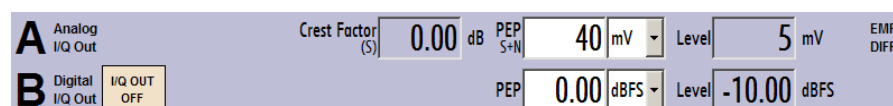

Operation via Graphical User Interface

• **Functional blocks**

Menus are assigned to the specific function blocks in the block diagram. The function blocks represent elements of signal generation. Function blocks displayed with a blue frame can be directly switched on and off by means of the TOGGLE ON/OFF (CTRL +T) key. The menus of the highlighted function blocks can be called by pressing the ENTER key.

– **Example:**

The "Baseband" block contains all menus required for baseband signal configuration.



In this block all digital standards and the digital modulation can be selected.



• **Signal flow**

The signal flow between the function blocks and the employed inputs and outputs are also shown.

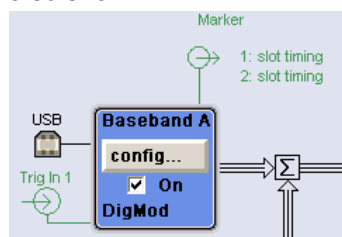

• **Menu tree**

The menu tree can be opened and closed with the MENU (CTRL+M) key. The menu tree is organized in the same way as the directories under Windows. The function blocks correspond to the first directory level, the menus to subdirectories.



Operation corresponds to the Windows concept

To offer the user a familiar environment, operation is very similar to operation of Windows user interfaces. All menus and tables are made up of known elements, such as selection lists, check boxes and entry fields.

A blue frame indicates that the selected item is active. In the highlighted element, entries can be made.

Rotary knob

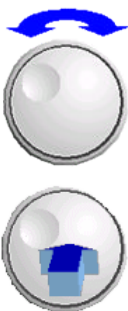

Operation is possible via front-panel keys, an external keyboard and the mouse. However, most of the settings can be easily made with the rotary knob:

- Turning the rotary knob shifts the entry focus to the target element.
- Pressing the rotary knob activates the selected entry field. Depending on the parameter, the submenu is called, the numeric value varied, the list entry selected or the check box activated or deactivated.
- If a value is entered, the entry is stored by another click on the rotary knob and the editing mode is exited.

Clear settings with the aid of independent subdialogs

A separate window is opened for each dialog and subdialog. The dialogs can be operated independently of each other, i.e. none of the dialogs requires that settings in other dialogs be completed before it can be closed. This ensures flexible operation at all times.

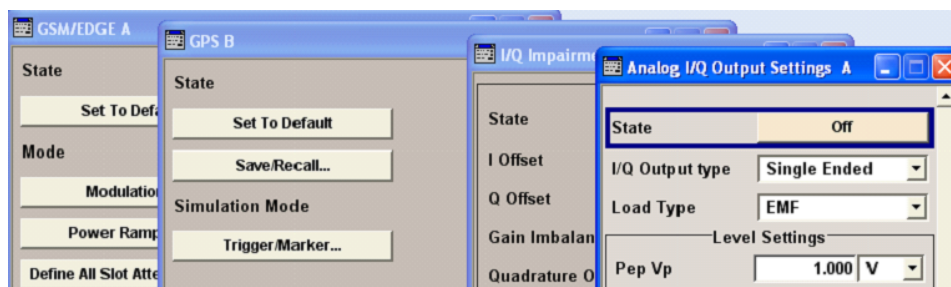

Winbar

The Winbar gives an overview of menus and simplifies their access.

The menus are displayed on top of the block diagram but they can be "hidden" with the aid of the HIDE (CTRL+H) key, i.e. displayed in the form of a button in the "Winbar" at the lower end of the screen.

They can be displayed again in full size by a keystroke (REARR (CTRL+A) key). This makes room on the screen for other displays that may be required but the setting menus can be still accessed any time.

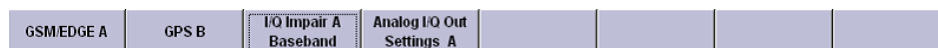

Keys with assigned simple functions

Most keys on the front panel of the R&S AMU directly perform a simple function.

Since a great number of settings can thus be made by a keystroke, operation is easy. For instance, the CLOSE (ESC) key closes the active menu; with the BASEBD ON/OFF (CTRL+R) key the baseband output signal can be switched on or off

An exception are keys that call a menu such as the MENU (CTRL+M) key which opens the complete menu tree of the instrument, the SETUP (CTRL+E) key which opens the

menus for general instrument settings or the FILE (CTRL+S) key which opens the menu for file management.

Help functions for user support

Numerous help functions support the user in signal configuration.

- **Value ranges**

The valid setting range is displayed for each numeric parameter. This requires a short wait after activation of the entry field. The range is then displayed automatically after a few seconds.

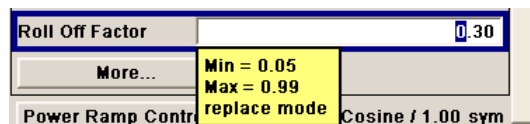

If the entered value is outside the permissible range, the next permissible value is automatically set and a message is output.

- **Context-sensitive help**

Context-sensitive help for each parameter can be called with the HELP or F1 key.

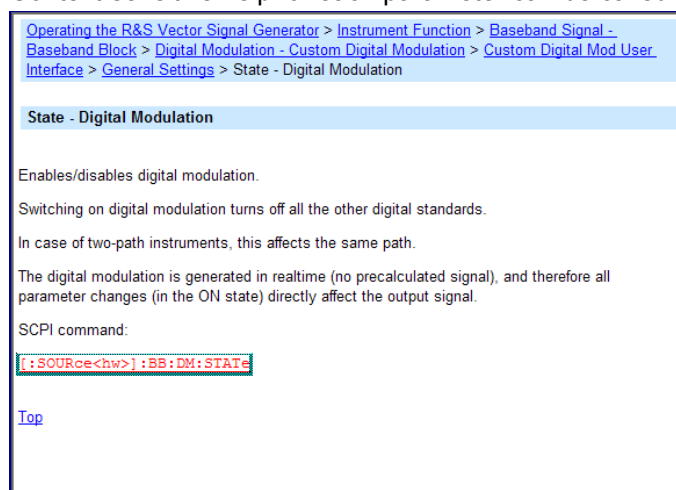

- **Comprehensive online help**

Each help page is part of a comprehensive online help function which can be called by means of an index, a content tree or the "Previous/Next" buttons.

Info line with messages for indication of the current instrument state

A great variety of different messages such as status messages, error messages, warnings or information are displayed in the header field of the screen. With the aid of the INFO (CTRL+I) key, help pages can be called for most of the messages. They provide background information on the message and indicate operating steps that may be required. All messages are explained in the online help which can be called with the HELP (F1) key.

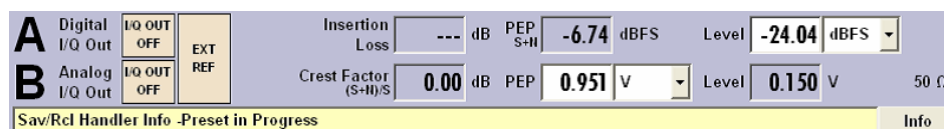

Graphical display of data structure

The structure of the baseband signal is graphically displayed in the respective menus; the individual signal elements can be graphically selected for processing.

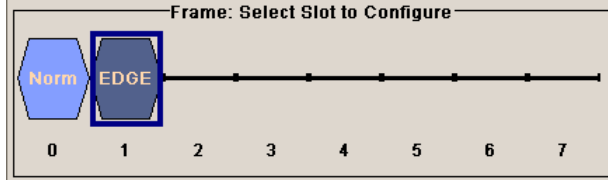

Graphics editor for definition of control signals

Control signals are also graphically configured.

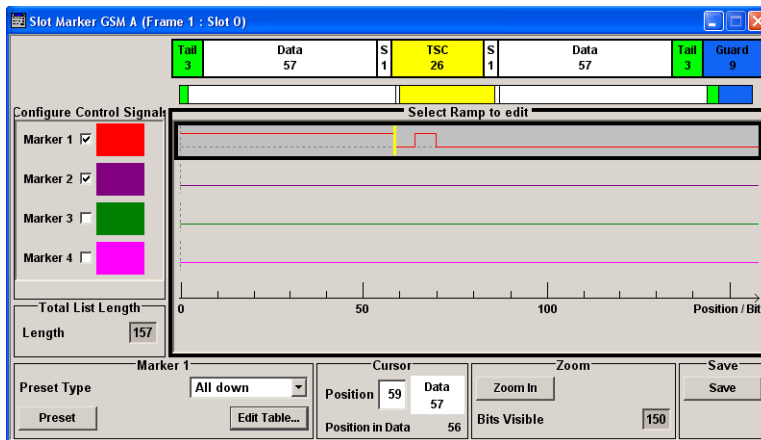

Graphical display of output signal in a diagram

The output signal can be graphically displayed in a number of diagrams. This allows a fast check of signal characteristics. Zoom functions and the insertion of a reference trace permit in-depth evaluation without an external analyzer being required.

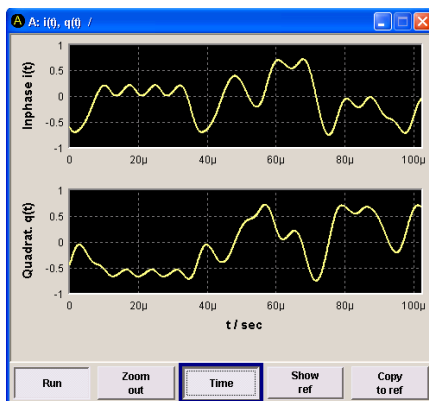

4.2 Display

The display shows the current signal generator state and offers graphical elements for direct operation. It is divided into three sections:

- The frequency and level display with info line indicates the main output signal parameters and reports the current state with status, error and warning messages.
- The block diagram shows the instrument configuration, the signal characteristic as well as the inputs and outputs used and permits interactive operation via graphics elements. Active menus and graphs are displayed on top of the block diagram.
- Winbar with labelled softkeys for menu display.

The block diagram in the figure below shows a fully equipped instrument.

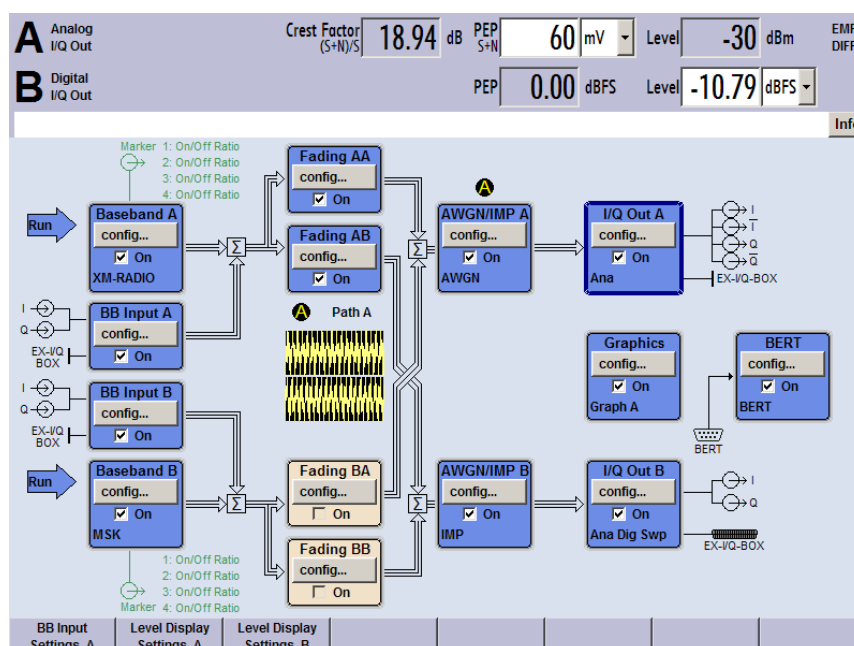

Fig. 4-1: Display of a fully equipped R&S Signal Generator

4.2.1 Settings Displayed in the Header Section

Level settings and a few status messages (see [chapter 4.2.2, "Status Information and Messages"](#), on page 85) are displayed in the header field of the screen. The display may vary depending on the instrument's operating mode:

- In case of two-path instruments, the baseband signal information on the two paths is displayed separately for each path.
- **PEP** indicates the peak envelope power and **Level** indicates the output voltage at the I/Q output.
- Additionally, auxiliary information on the parameters insertion loss or crest factor of the I/Q output signal is displayed.



The value displayed in the "Freq" and "Level" field does not consider any offset set or multiplier factor.

For more information see "RF Frequency and Phase" and "RF Level" in the Operating Manual.

4.2.2 Status Information and Messages

The status information and messages are displayed in the header section of the screen. The messages differ with respect to their importance (errors, warnings, info) and the time of their appearance (brief and permanent messages). They require different treatment by the user. Further information on all messages can be called in the info window (see [chapter 4.2.3, "Info Window"](#), on page 86).

Refer to "Error messages" in the Operating Manual for an overview of all status information and messages as well as instructions for error elimination.

4.2.2.1 Status Information

The status information gives the user an overview of the main operating states and settings of the instrument. The states are indicated for information only and do not necessitate any action by the user.

Status information is displayed between the information on the current mode of the base-band output signal and the level fields, at the left of the info line or in the info line itself.

On two-path instruments, all states that can occur independently in the two paths are displayed separately for each path. The associated path is indicated in the info line.

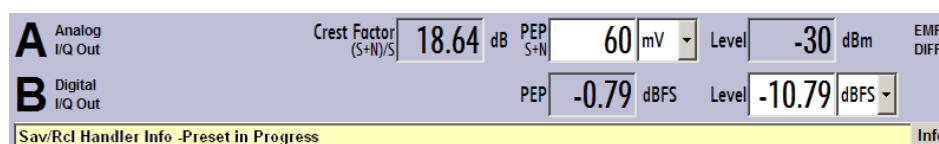

4.2.2.2 Messages

Messages indicate errors in the instrument. They are displayed in the info line in different colors depending on their importance and display duration. Errors (e.g. no calibration data) are displayed in red, information (e.g. file not found) and warnings in black. Warnings indicate less significant errors (e.g. the instrument operates outside specified data).

4.2.2.3 Volatile messages

Brief messages report automatic settings in the instrument (e.g. switching off of incompatible types of modulation) or on illegal entries that are not accepted by the instrument (e.g. range violations). They are displayed in the info line on a yellow background. They are displayed on top of status information or permanent messages.

Volatile messages do not normally demand user actions and disappear automatically after a brief period of time. They are stored in the history, however.

These messages can be read from remote using `SYST:ERR?` or `SYST:ERR:ALL?`.

4.2.2.4 Permanent Messages

Permanent messages are displayed if an error occurs that impairs further instrument operation, e.g. a hardware fault. The error signalled by a permanent message must be eliminated before correct instrument operation can be ensured.

The message is displayed until the error is eliminated. It covers the status display in the info line. After error elimination, the message automatically disappears and is also recorded in the history.

These messages can be read from remote using `SYST:SErr?`.

4.2.3 Info Window

A few operating states and the current message are displayed in the info line.

The INFO window with a list of current permanent messages and a detailed description of each message can be opened with the INFO (CTRL+I) key.

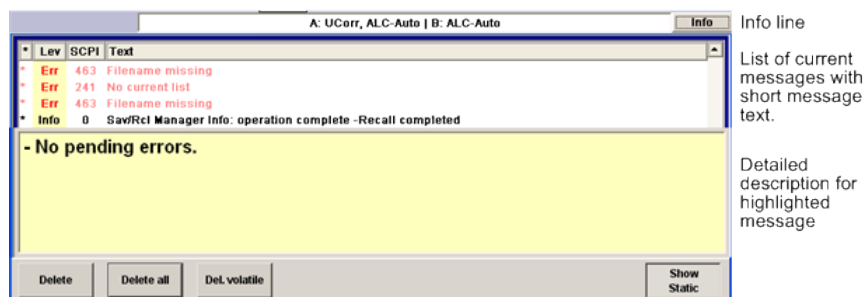

The upper section of the info window contains a list of all current permanent messages in the order of their occurrence, i.e. the most recent message is displayed first. In the lower section of the window, additional information on the highlighted message is displayed. A history of all messages that have occurred since instrument switch-on can be called with the "History" key. The most recent message is displayed first.

The messages are color-coded according to their level. Device-specific messages are red, info and remote control error are black. The level is also indicated in the "Lev" column (Err, Sys or Info). Column "SCPI" indicates the SCPI error code.

With the aid of the softkey buttons, error messages can be cleared and a history of all messages called.

Delete

Clears the highlighted message.

This button is available only if the history of the messages is displayed.

Delete All

Clears all messages.

This button is available only if the history of the messages is displayed.

Del. volatile

Clears all volatile messages.

This button is available only if the history of the messages is displayed.

SCPI command:

SYST:ERR:ALL?

Each time a SYST:ERR:ALL? query is sent, the error queue is returned and at the same time cleared.

History

Calls the list of all messages that have occurred since instrument switch-on. The most recent messages are displayed at the top of the list. When the button is pressed again, the list of current messages is displayed.

SCPI command:

SYST:ERR? or STAT:QUE?

Each time a SYST:ERR? or STAT:QUE? query is sent, the oldest entry in the error queue is returned and at the same time cleared in the list.

4.2.4 Block Diagram

The block diagram shows provided options, signal configuration and the currently selected signal flow of the generator with inputs and outputs used. Signal generation can be completely operated from the block diagram. The highlighted function block can be directly switched on and off with the TOGGLE ON/OFF (CTRL+T) key. Pressing the Enter opens the associated setting menu.

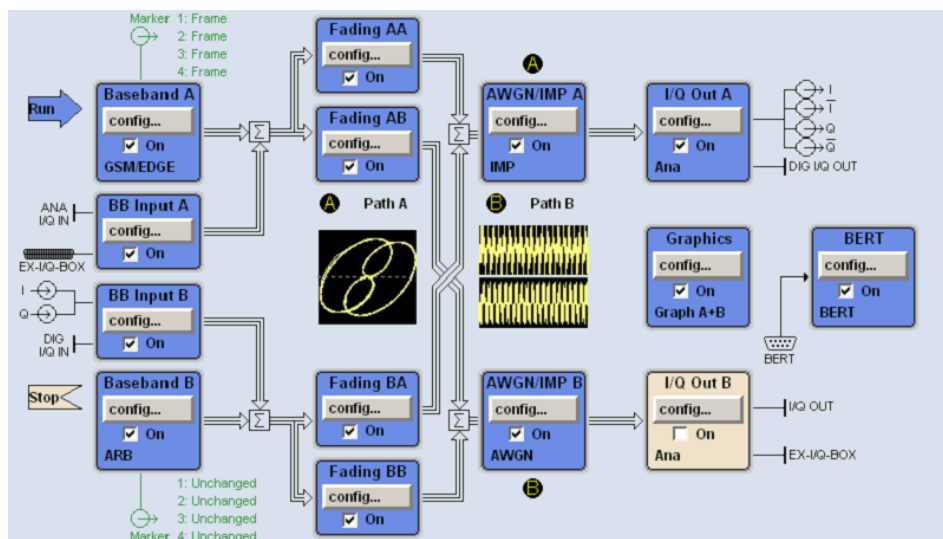

4.2.4.1 Function Blocks in the Block Diagram

Each block represents a function of signal generation. The function is indicated in the headline of the block. In the check box, the respective function can be quickly activated/deactivated with the TOGGLE ON/OFF (CTRL+T) key. After activation, the block is displayed in blue. Status information is displayed below the check box. It is different for the different blocks.

Pressing the rotary knob (front panel) or the "Config..." button (mouse) opens the associated setting menu.

In all function blocks where the signal flow can be influenced, the top menu level for setting signal routing parameters is offered.

Example: Baseband block

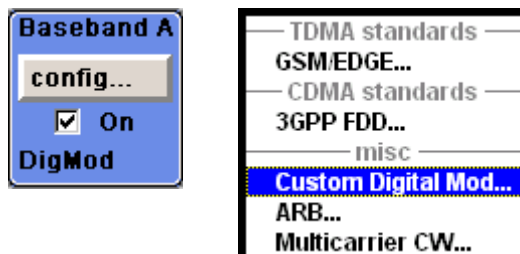

In this block, the digital modulation signal, the digital standards, arbitrary waveform generation and multicarrier CW are set. The status information of the "Baseband" block indicates the selected modulation and associated additional information, e.g. the number of channels.

4.2.4.2 Signal Flow and Input/Output Symbols in the Block Diagram

The input/output symbols in the block diagram show the currently used inputs and outputs of the signal generator. Unused inputs and outputs are not shown. The lines indicate the signal flow.

Symbols and labels refer to the corresponding inputs and outputs on the front and rear panel of the signal generator. The direction - input or output - is indicated by an arrow.

Example:

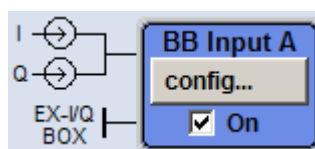

The symbols indicate the inputs for the analog I and Q signal on the instrument front panel.

If several markers are active, the marker characteristics are listed next to the marker symbol of the active markers.

Symbols and lines are displayed in different colors depending on their function.

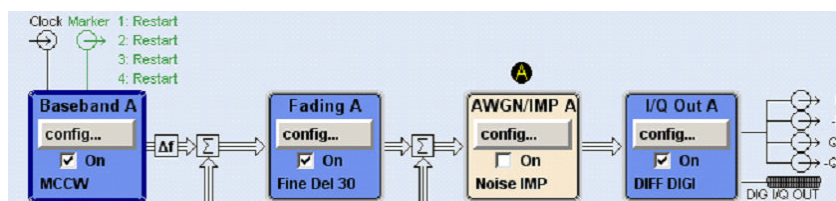

- The baseband signal is indicated by a three line arrow, the I- and Q-components of the signal by a single-line arrow.
- Addition of signals is indicated by the summation sign.
- Connections are indicated by a "solder point".
- Black is used for the generated signal.
- Green is used for control signals.

The signal flow is configured in the individual menus. User interfaces are configured in:

- the "Setup > USER Marker /AUX I/O Settings" dialog and
- the "Setup > Global Trigger/Clock/External Inputs" dialog.

4.2.5 Winbar and Softkeys

The "Winbar" with eight buttons is displayed below the block diagram. Labelled buttons represent open menus, the label indicates the menu. If several menus are open, the button of the currently active menu is displayed in a lighter colour. The buttons also assign functions to the softkeys of the next lower level for front-panel operation. Up to eight menus may be open simultaneously. When the ninth menu is opened, the menu that was opened first is automatically closed.

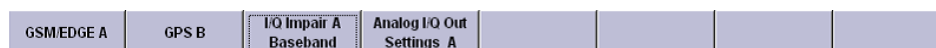

Some menus, e.g. data and list editor menus, cover the "Winbar" and assign menu-specific functions to the front-panel softkeys by way of the menu buttons.

Any of the open menus can be activated either with the respective button in the "Winbar" or the front-panel softkey. In combination with the keys for menu operation (CLOSE (ESC), HIDE (CTRL+H) and REARR (CTRL+A)), convenient menu operation can be ensured.

Working with menus and dialog boxes is described in [chapter 4.3, "Accessing Dialogs"](#), on page 91.

4.2.6 Structure of the Dialogs

The parameters are set in the menus. Menus are accessed either via the function blocks in the diagram or by means of the MENU (CTRL+M) key. The menus are displayed on top of the block diagram.

If the menu buttons assign menu-specific functions to the softkeys, the "Winbar" is hidden.

Working with menus and dialog boxes is described in [chapter 4.3, "Accessing Dialogs"](#), on page 91; the setting of parameters in [chapter 4.4, "Setting Parameters"](#), on page 92.

The menus are in Windows format. The menus differ in details depending on their function but they consist of the same main elements. Each menu consists of a menu header and one or more menu areas with various fields for setting parameters.

The header line contains the name of the menu and the buttons for minimizing and closing the menu. To operate the buttons, use the mouse or the front keys HIDE (CTRL+H) and CLOSE (ESC).

Several fields of associated but separately set parameters are organized in menu areas. A menu area is framed and labelled with the function common to all parameters.

Example: Impairments

Impairments	
State	<input type="checkbox"/>
I Leakage	0.00 %
Q Leakage	0.00 %
Imbalance	0.00 %
Quadrature Offset	0.00 deg

Each of the setting fields is assigned a parameter name. The kind of setting varies depending on the parameter to be set. Some settings can only be made in a specific configuration. If setting is not permitted with the specific configuration selected, the respective item is disabled and displayed in gray and the entry or selection field cannot be accessed.

4.2.7 Graphical Display of Output Signal Characteristics

The graphical display of the output signal enables the user to rapidly check signal characteristics without connecting an analyzer. Zoom functions and the display of a reference trace allow in-depth evaluation. The diagram is displayed on top of the block diagram. It can be minimized and called in the same way as a menu.

Example: I/Q diagram

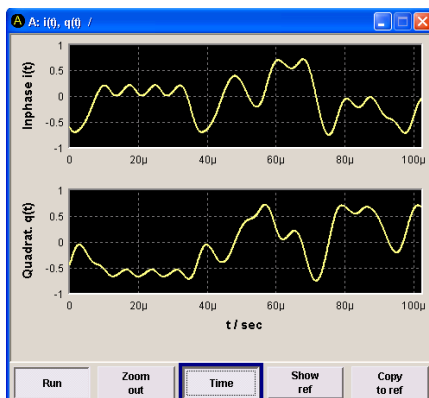

To access the "Graphics Settings" dialog for selecting the graphics display of the output signal, select the "Graphics" function block in the diagram or press the MENU (CTRL+M) key.

Operation of the graphics windows is analogous to menu operation.

The menu and the individual graphical displays are described in "Graphics Display" in the Operating Manual.

4.3 Accessing Dialogs

The MENU (CTRL+M) key opens the complete menu tree. Selecting a functional block and pressing the ENTER key opens the menu associated with this block.

An alternatively way to access a dialog is to use the Winbar buttons or front-panel softkeys or to use the HIDE (CTRL+H), CLOSE (ESC), DIAGRAM (CTRL+D) and REARR (CTRL+A) keys on the front panel.

For a quick access to the dialogs, use one of the following alternative methods.

Displaying the block diagram or a dialog in the foreground

1. Press the DIAGRAM (CTRL+D) key to move the cursor to the block diagram.
All active menus are minimized and displayed in the form of Winbar buttons.
2. Press the associated softkey (CTRL+F1 .. F8) to display the dialog in the foreground again.

Accessing the menu tree

- ▶ Press the MENU (CTRL+M) key to open the complete menu tree.

Calling the File, Setup or Hardcopy dialogs

- ▶ Use the FILE (CTRL+S), SETUP (CTRL+E) or HCOPI (CTRL+Y) keys to open the respective dialog.

Minimizing an active menu

- ▶ Use the HIDE (CTRL+H) key to minimize an active menu.
It is displayed in the form of a Winbar button.

Automatically arranging displayed menus

- ▶ Press the REARR (CTRL+A) key to rearrange all open menus so that they overlap as little as possible.

Activating the Windbar

- ▶ Use the WINBAR (CTRL+W) key to toggle the cursor between a button of the "Winbar" and the block diagram.

The button that was active last in the Winbar is highlighted.

Closing an active menu

- ▶ Press the CLOSE key to close an active menu.

Tip: If the cursor is at the highest menu level, you can also use the ESC key to close the active menu.

Accessing the header area

- ▶ Press the BASEBD LEVEL (CTRL+R) key to activate the "PEP" or "Level" entry fields in the header area. Press the BASEBD LEVEL (CTRL+R) key again to switch between the active input fields.



Keyboard Shortcuts

Keyboard shortcuts (e.g. "Ctrl + D" for the displaying the block diagram in the foreground) provide direct access to all utility dialogs of the instrument (see [chapter 4.8, "Legend of Front-Panel Controls"](#), on page 112).

4.4 Setting Parameters

The R&S AMU offers several and sometimes alternative possibilities for setting parameters. Operation is possible from the front panel, with the aid of a mouse and/or from a PC keyboard.



The examples within this description focus on the operation from the front panel.



For more information, refer to:

- [chapter 4.8, "Legend of Front-Panel Controls"](#), on page 112 for an overview of key functions and a cross-reference between the front panel keys and the keyboard shortcuts
 - "Instrument Functions" in the Operating Manual for a detailed description of key functions.
-

Most of the parameters are set in the different menus. The R&S AMU provides alternative ways for accessing the dialogs. Turn the rotary knob and navigate to the corresponding block in the block diagram and press the knob to open the dialog or perform a mouse click on the "Config..." button.

An exception are the "Setup", "File" and "Hcopy" dialogs. In the "Setup" dialog, general settings are made which are not directly concerned with signal generation, e.g. setting of the GPIB-bus address. In the "File" dialog, files and lists are managed; in the "Hcopy" dialog, printout is configured and hardcopies can be made. These menus can only be called with the SETUP (CTRL+E), FILE (CTRL+S) and HCOPY (CTRL+Y) keys.

Level parameters are directly set in the header area of the display using the BASEBD LEVEL key. Some of the keys trigger a direct action, e.g. the BASEBD ON/OFF key switches the baseband output on and off. Changes affecting the signal flow are immediately visible in the graphics display.

The R&S AMU uses the Windows XP® operating system. Settings at system level are only rarely required, e.g. installation of a new printer driver. For convenient operation of Windows XP®, a keyboard and a mouse are required.

This section provides an information about the parameter handling that comprises of the following main steps:

- [chapter 4.4.1, "Working with the Cursor"](#), on page 93
- [chapter 4.4.2, "Selecting a Control Element"](#), on page 94
- [chapter 4.4.3, "Switching Parameters On/Off"](#), on page 94
- [chapter 4.4.4, "Entering a Value"](#), on page 94
- [chapter 4.4.5, "Working with Units "](#), on page 96
- [chapter 4.4.6, "Selecting a Value from a List"](#), on page 97
- [chapter 4.4.7, "Terminating Entries with Confirmation"](#), on page 97
- [chapter 4.4.8, "Restoring the Previous Value"](#), on page 98

4.4.1 Working with the Cursor

After the instrument is switched on, the cursor is always on the first function block of the diagram (default setting).

Moving the cursor on the display

► To move the cursor, use one of the following alternative methods:

- a) Use the rotary knob or the arrow keys.
- b) Use the appropriate softkeys (CTRL+F1..F8) to move the cursor to the "Winbar".
If the "Winbar" is covered by a menu, press the WINBAR (CTRL+W) key to display it in the foreground.
- c) Use the ESC key.

Tip: Be aware that the function of the ESC key depends on the current cursor position. The function of this key depends on the current cursor position.

- Calls the next higher selection level.
- Closes the open window without accepting new entries; the old value or parameter is retained.
- In dialog boxes that contain a "Cancel" button it activates that button.
- Closes all kinds of dialog boxes, if the edit mode is not active.

- Quits the edit mode, if the edit mode is active.
- Switches between different entry fields of a menu.
- Shifts the entry cursor from the header display to the previously active menu, or to the previously highlighted block in the block diagram if no menu is active.
- Shifts the cursor from a function block in the diagram to the first item in the "Winbar". If no menus are open, the current cursor position remains unchanged.

Moving the cursor to the heading area

- ▶ Press the BASEBD LEVEL (CTRL+R) key to activate the "PEP" or "Level" entry fields in the header area. Press the BASEBD LEVEL (CTRL+R) key again to switch between the active input fields.

4.4.2 Selecting a Control Element

Control elements are always selected in the same way no matter whether a function block in the diagram, a menu in the menu tree, a parameter in the menu or an entry in a list or table is concerned.

- ▶ To activate an element, put the cursor on it.



An active element is highlighted by a blue frame.

4.4.3 Switching Parameters On/Off

A parameter can be activated and deactivated using a button or a check box.

1. Select the parameter.
2. To change the state of a parameter, use the "Enter" function of the different control media:
 - Press the rotary knob
 - Press ENTER
 - Press the TOGGLE ON OFF (CTRL+T) key.

Colour and label of a button change, the check box is ticked or the tick is removed.

4.4.4 Entering a Value

Numeric and alphanumeric values can be edited in the entry fields. In the editing mode, cursors of different colour are used. A blue cursor indicates the overwrite mode, a green cursor the insert mode.



Changing between the Insert and Overwrite mode

The insert mode is the default setting.

Use the INSERT key to toggle between the insert and overwrite mode.

Numeric and alphanumeric values can either be newly entered or the existing value can be changed. Incorrect entries are cleared with the BACKSPACE key.

Entering a new numerical value

1. Select the parameter.
2. Press a numeric key to activate the editing mode.

The previous value is cleared and the new value can be entered.

Editing a value in the insert mode (default setting)

1. Press the rotary knob (= Enter) to activate the editing mode.
If the cursor is placed at the right of the total value, the insert mode is always active.
2. Set the cursor to the left of the number to be changed using the LEFT/RIGHT arrow keys.
The cursor is displayed in green.
3. Click on a numeric key to insert a new value.



Editing a value in the overwrite mode

1. Activate the editing mode.
2. Set the cursor on the numeric digit to be changed using the LEFT/RIGHT arrow keys.
The cursor is displayed in blue and the number to be replaced is highlighted.
3. Click on a numeric key to overwrite the highlighted value.



Varying a value

1. Activate the editing mode.
2. Set the cursor to the left of the number to be changed using the LEFT/RIGHT arrow keys.
The value at the cursor position is varied.
3. To vary the selected value, use the UP/DOWN arrow key or turn the rotary knob.
The value is increased or decreased.

Entering a new alphanumerical value

1. Select the parameter.
2. Press an alphanumeric key to start the editing mode.

The new value is entered.

Editing an alphanumerical value

An existing value, e.g. a file name, can be changed in the insert mode (see example) or in the overwrite mode.

1. Select the parameter and activate the editing mode.
2. Set the cursor to the left of the alphanumerical value using the LEFT/RIGHT arrow keys.

Tip: If hexadecimal values are to be entered, the numeric front-panel keys are automatically changed to hexadecimal values.

3. Click on an alphanumeric key to insert a new alphanumerical value.



Terminating the entry of a numeric value

To terminate the entry of a numeric value:

1. Press the rotary knob (= Enter).
2. Press a UNIT key on the front panel.
3. Select a "Unit" in the selection field next to the parameter value.

4.4.5 Working with Units

The unit of a parameter is displayed next to the value. When the parameter is edited, the unit is selected either from the list or by means of the front-panel keys. When the entry is completed, the unit can be changed. In this case the value remains unchanged but is automatically adapted to the new unit.



While operating the instrument by means of a mouse, assign the unit to the selected parameter before entering its value.

Assigning a unit

To assign a unit to a value, use one of the following alternatives:

1. Press a UNIT key on the front panel.



2. Select a "Unit" in the selection field next to the parameter value.

Press the ENTER key.

The unit displayed in the entry field next to the value is assigned.

Changing a unit

To subsequently change a unit, i.e. after the entry has been terminated and when the editing mode is not active, use one of the following alternatives:

1. Press a UNIT key on the front panel.
2. Select "Unit" in the selection field next to the parameter value.

The value remains unchanged but the display is automatically adapted to the new unit, i.e. the value is recalculated to suit the new unit.

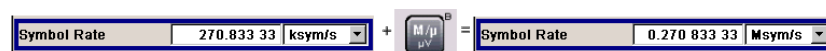

The new unit is indicated in the value field of the menu.

4.4.6 Selecting a Value from a List

Selection lists provide a list of predefined values for the selected parameter.

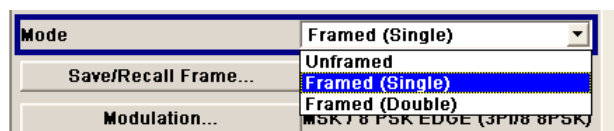

To select a item from a list, proceed as follow:

1. Press ENTER key to open the list.
2. Use one of the following alternatives to navigate through the list:
 - a) Turn the rotary knob or use the UP/DOWN arrow keys.
The selected item is highlighted.
 - b) Press TOGGLE ON/OFF key several times until the preferred entry is displayed in the selection field.
3. To confirm the selection, press the ENTER key.

4.4.7 Terminating Entries with Confirmation

The instrument behaves different by the termination of entries depending on the parameter type and the way this parameter is set.

Confirming settings

- ▶ To confirm the settings, press the rotary knob or one of the UNIT keys (see also [chapter 4.4.5, "Working with Units"](#), on page 96).

Note: Variations by means of the rotary knob are immediately set.

Confirming multiple values

In some cases, like for instance when configuring the carriers for a multicarrier CW signal in a carrier table, it is useful first to enter few values and to confirm them together. Such settings require additional confirmation. Not yet confirmed settings are displayed on a yellow background as an indication that the currently displayed values do not represent the target signal.

- ▶ To confirm these settings, select the "Accept" button.

Confirming parameters with On/Off state

Most of the instrument functions with enabled and disabled states are calculated and effective only after this functions have been enabled. However, there are functions like the frequency variation of the reference oscillator for instance, that are immediately set after confirmation.

- ▶ To confirm a parameter with On/Off state, enable the parameter.

If time-consuming calculations are required, signal generation is automatically switched off and calculation is interrupted to allow the user to make further settings. Calculation is restarted with the RECALCULATE key and the modulation is switched on again when the calculation is completed.



Preventing recalculation

If an instrument function requires several parameter settings, switch the function off to prevent a recalculation.

Enable the function after the entire configuration of the settings have been completed. The signal is recalculated only once.

4.4.8 Restoring the Previous Value

Parameter variations with the rotary knob are immediately set and therefore not reversible.

Normally, values cannot be restored in the case of mouse control because no explicit confirmation is required in this case and entries are automatically confirmed when the entry or selection field is exited.

Restoring values

In the case of front-panel control or operation from the keyboard, previous values can be restored as long as the new value is not confirmed, i.e. the entry is not completed.

- ▶ To restore the values, press the ESC key.

Restoring values that require confirmation

All settings that are not confirmed with the "Accept" button but require this additional confirmation can be restored.

1. Press the ESC key.

A confirmation query is displayed.

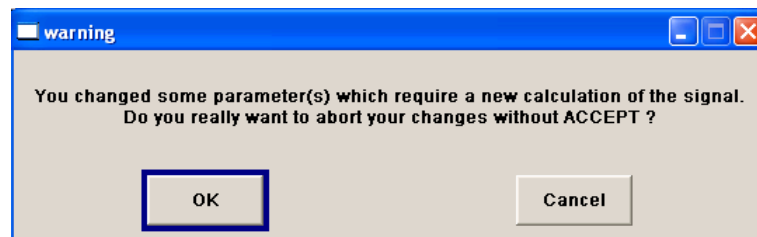

2. Confirm with "OK" to abort the changes.
Select "Cancel" to return to the dialog. The previous selected settings are displayed.

Restoring values after an extended calculation has been started

Calculation and setting might require different period of time. Many settings are made without noticeable calculation times; such operations are indicated by a "BUSY" message displayed in the status field of the header section.

A window with a progress indicates that the instrument performs an extended calculation that requires longer calculation time. The termination of such a calculation restores the previous values.

- ▶ Press the ABORT button to terminate the calculation.
All previous values are restored.

4.5 Editors

The R&S AMU provides user-friendly editors for defining data lists as well as control and marker signals.

Internally generated data lists can be used for digital modulation and digital standards; the same applies to internally defined control and marker signals.

The lists are saved to files and may thus have any length. The file name of the lists and the directory to which the files are saved are user-selectable. The file prefix is different for each list type and is permanently assigned by the system.

For information about file handling and overview of the automatically assigned file prefixes, refer to [chapter 4.7, "File Management"](#), on page 106.

4.5.1 Working with Data Editor

The "Data Editor" is used to internally generate binary data lists for digital modulation and digital standards.

A list of binary values with a maximum length of 2^{31} bits can be entered in the "Data Editor". This value corresponds to a file size of approx. 268 Mbyte. While it is being processed, the file is continuously automatically buffered. When the dialog is exited, the file

is automatically saved with the new values, i.e. there is no extra "Save" button. Depending on the size of the file, saving may take some time.

Editing an existing data list

1. To **access** a data editor and open an existing data list for editing, use the arrow keys to select the associated button "Edit Data List..." in the individual menu.

The selected data list is displayed.

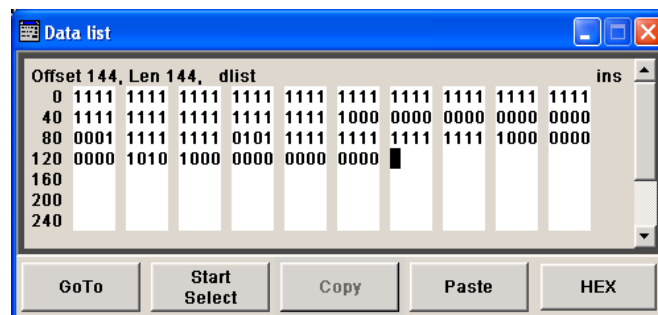

The cursor marks the start value of the list.

To increase readability, the bits are displayed in groups of four. The current cursor position, the length of the list and the list file name are displayed above the list. The offset starts with the value 0 which corresponds to the bit position on the left side of the first row, i.e. the beginning of the list. On the left edge of the editor, the last three offset positions are specified at the beginning of the row.

2. Use the numeric keys to enter the values 0 or 1.
An existing list can be edited in the insert or overwrite mode. Use the INSERT key to toggle between these two modes.
3. To **delete** a value, use the arrow keys to mark the bit that follows the value to be deleted.
Press the INSERT key to activate the insert mode. Values cannot be deleted in the overwrite mode.
Press the BACKSPACE key.
The value before the marked bit is deleted.
4. To **select a bit position**, select the "GoTo" button and press the ENTER key.
Enter the bit position in the "GoTo Offset" entry field by means of the numeric keys and confirm the entry.
The cursor marks the bit at the selected position.
5. To **copy and paste** any range of bits at any position in the list:
 - a) Use the the arrow keys to mark the start bit of the selection.
 - b) Select the "Start Select" button and use the the arrow keys to mark the selection.
 - c) Click the "Copy" button.
 - d) Navigate to the insert position and select "Paste".
 The selected and copied bits are pasted after the selected position.
6. To **display and edit** the values in hexadecimal form, select the "Hex" button.

Each four bits are displayed as a hexadecimal value: To increase readability, the hexadecimal values in turn are displayed in pairs of two. The hex functions are automatically assigned to the numeric keys at the front panel.

- To **save** the data list, press the ESC key.

The list is saved automatically when the dialog is closed.

Creating a new data list

- To create an empty data list, in the individual menu select "List Management > Select Data List to Edit... > Create Data List" and enter the file name of the new data list.
- To open the data list for editing, select the associated button "Edit Data List..." in the individual menu.

4.5.2 Working with Control and Marker List Editor

The control and marker signals for digital modulation and digital standards can be very conveniently graphically defined in a "Control and Marker List Editor". The available marker signals – and, with custom digital modulation, the CW, Hop, Burst Gate and Lev Att control signals – can be defined in this editor.

While it is being processed, the file is continuously automatically buffered. Depending on the size of the file, saving may take some time.



The various functions of the editor are explained in the individual menus. This section focuses to the general use of the graphic editor.

Example:

The following figure shows the "Slot Marker Definition Editor" of the "GSM/EDGE" dialog as an example.

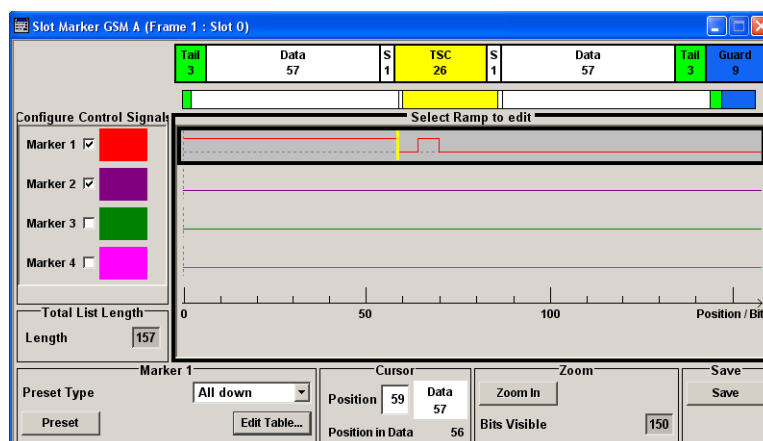

The upper area displays the signal for which the marker signals are to be defined. On the left side, the available signals (marker and control signals) are listed and colour-coded.

Auxiliary functions are offered in the lower editor area, e.g. presetting for the ramps in the marker signal, cursor positioning by entering the bit position and possible editing by means of value entries in a table.

The actual graphic definition of the control signals occurs in the center area of the editor. Each control signal is represented by means of a colored line along the bit axis. A cursor can be shifted alongside this line and marks the position where a ramp is to be set. The color of the cursor changes depending on the current function.

Use the ENTER key to switch over between the colors (and therefore functions):

- black: marks the bit position on the marker line
- yellow: sets a ramp
- green: activates the marked ramp for shifting.

Accessing control and marker list

1. To access the control list editor (e.g. "CList Dig Mod") and open an existing list for editing, use the arrow keys to select "Custom Digital Mod > List Management > Edit Control List".

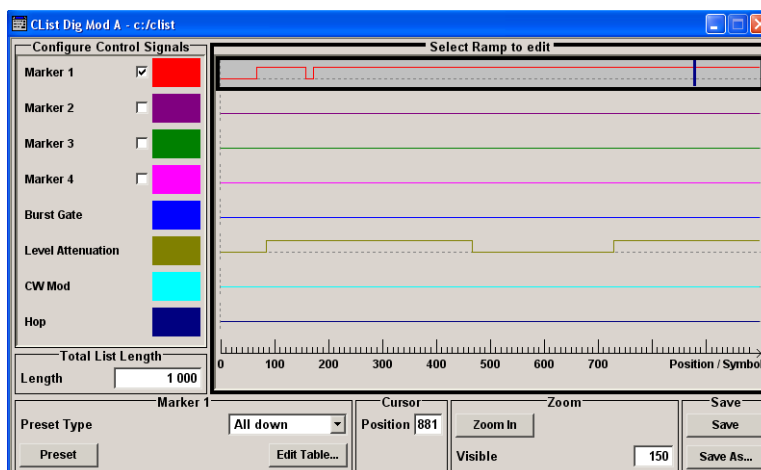

2. To access the slot marker list editor (e.g. "Slot Marker") and open an existing list for editing, use the arrow keys to select "GSM/EDGE > Burst Editor > Slot Marker Definition".

Editing an existing control or marker list

1. Activate control/marker signal line for editing.
Use the arrow keys to mark the editable graphic area and press the ENTER key.
Select the control/marker signal line to be edit and press the ENTER key.
The cursor is active for the selected line.
2. Define the cursor position.
Select the parameter "Cursor Position", specify the position by means of the numeric keys and confirm the entry.

The cursor is positioned according to the entry. If the entered value exceeds the selected length of the definition range, the length is adjusted automatically.

3. Configure the control and marker signals (see ["Handling of Ramps"](#) on page 103).
4. Define length of control list ("Custom Dig Mod" only).
Select the "Total List Length" entry field and press the ENTER key. Enter the length by means of the numeric keys and confirm the entry.
The control list length is defined.
5. Zoom displayed range ("Custom Dig Mod" only) in long control lists.
To zoom the displayed area around the current "Cursor Position", select the parameter "Visible/Bits Visible", enter the number of symbols/bits to be displayed by means of the numeric keys and confirm the entry.
Select the "Zoom In" button and press the ENTER key.
The selected number of symbols/bits around the current cursor position are displayed.
Ramps outside the displayed area are not lost by zooming.
6. Use the "Save"/"Save As..." function to save the edited control/marker list under its current name or under a new name.
Enter the file name in the "Create File" dialog and select the directory (see [chapter 4.7.1, "File Select Dialog"](#), on page 108).

Handling of Ramps

1. Set a new ramp
Use the arrow keys or use the parameter "Cursor Position" to move the cursor to the position where the ramp is to be inserted. Press the ENTER key.
The ramp transition of the newly set ramp depends on the current status (high or low) of the control signal. If the signal is low, a ramp with low-high transition is generated; if the signal is high, a ramp with high-low transition is generated.



When ramps are set between existing ramps, the transition of the new ramp is also defined by the status of the signal before the new ramp. For this reason, a ramp that has already been set can be assigned low-low or high-high transition (as in the example), i.e. it will have no effect on the control signal in this configuration. However, the ramp remains saved, and its position is indicated by a dashed line.

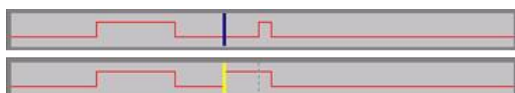

If another change produces effective transition, this ramp will be regenerated.

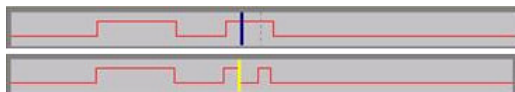

2. Shift a ramp
An existing ramp can be shifted to any positions. The transitions are adjusted accordingly.

Use the arrow keys to move the cursor to the ramp position; the cursor changes colour.

Press the ENTER key. The cursor again changes colour. The ramp will now be shifted by means of the cursor. Press the ENTER key. The ramp will be set at the current position.

The ramp transition depends on the status (high or low) of the control/marker signal before the ramp.



3. Delete a ramp

Use the arrow keys to move the cursor to the ramp position; the cursor changes colour.

Press the BACKSPACE key.

The ramp will be deleted. The ramp transitions of the other ramps are adapted to the changed signal status (high or low).
4. Set the ramps in a table

Select the "Edit Table..." button and define the positions and states of the ramps for the selected marker.

Confirm the entries with "Accept".
5. Preset a marker signal

Select the "Preset" button to preset the marker signal.

The ramps of the selected marker are adjusted according to the selected "Preset Type".

Creating a new control list

A new control list can be created under a new name either by generating a blank file or by changing an existing list which will then be saved under a new name.

1. To create an empty control list, select "BB > Cust Dig Mod > List Management... > Select Control List to Edit > Create Control List" and enter the file name of the new control list.
2. To open the control list for editing, select the associated button "BB > Cust Dig Mod > List Management... > Select Control List to Edit > Edit Control List..." and select an existing control list.

4.6 How to Use the Help System

The R&S AMU is equipped with a context-sensitive help function. A help page is available for each parameter and can be called any time during instrument operation.



Compiled online help systems are also available for all functions of the R&S AMU on the CD-ROM supplied with the instrument. This help program can be called on any controller with Internet Explorer version V4.0 and higher.

Calling context-sensitive and general help

- ▶ To display the general help dialog box, press the HELP (F1) key.

The help dialog is displayed. A topic containing information about the current menu or the currently opened dialog box and its function is displayed.

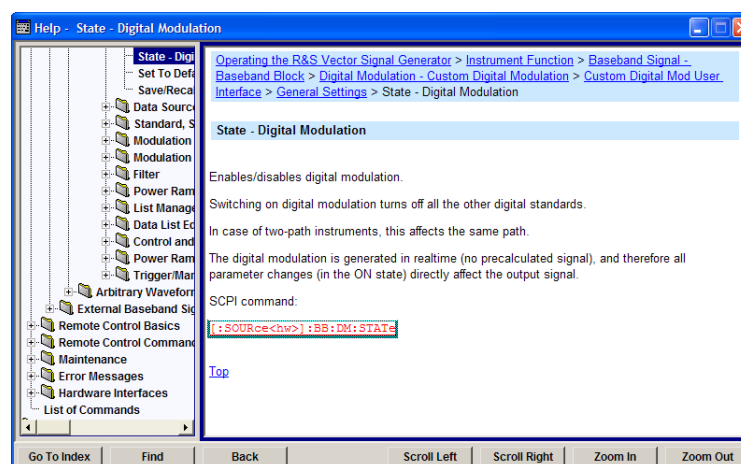

Contents of the help dialog box

The help dialog box contains two main areas:

- "Contents" - contains a table of help contents
- "Topic" - contains a specific help topic

The help system provides additionally an "Index" and a "Find" area, as well as "Zoom" functions that are accessed by means of the corresponding buttons.

Navigating in the table of contents

1. To move through the displayed contents entries, use the UP/DOWN keys. Entries that contain further entries are marked with a plus sign.
2. To display a help topic, press the "ENTER" key.
The corresponding help topic is displayed.

Navigating in the help topics

1. To scroll through a page, use the UP/DOWN arrow keys.
2. To jump to the linked topic, press the link text.
3. Use the "Previous" or "Next" links to jump to the corresponding topic.
4. Use the "Scroll Right" or "Scroll Left" buttons to shift the indicated area of the navigation window to the left or right.

Using the Index

1. Select the "Go to Index" button.
2. Enter the first characters of the topic you are interested in. The entries starting with these characters are displayed.
3. Press the ENTER key to change the focus.
4. Use the UP/DOWN keys to navigate and select the suitable keyword.
5. Press the ENTER key to display the help topic.

The corresponding help topic is displayed.

Closing the help window

- ▶ Press the HELP (F1) key.

4.7 File Management

The R&S AMU uses files to save all instrument data, i.e. system and user data.

The user data includes saved instrument settings, data for the different digital standards as well as the waveforms for the arbitrary waveform generator.

The files are stored on the hard disk of the instrument. Drive `D:\` can be used to save user-defined data; any directory structure can be created on `D:\`. Some default directories are predefined, but can be changed at any time. The `C:\` drive is a protected system drive. The files on this drive contain data that must not be changed. Therefore, this drive should not be accessed, since reconstruction of the system partition will lead to data loss. To prevent inadvertent deletion or overwriting of system files, this drive is not specified in the file menus. It can be accessed if a protection level (see section "Protection Level" in the Operating Manual) is revoked.

Files can be exchanged either via a memory stick or a connected network. A memory stick is connected to the USB interface and is assigned the `E:` drive. In the case of a connected network, all network drives that can be accessed are available. The files are accessed in a "Save/Recall" dialog in the individual menus.

The files are differentiated according to their extensions; each type of file is assigned a specific file content. The extension is usually of no consequence to the user since access to the files occurs in the individual menus where only the relevant type of file is available. See [chapter 4.7.2.1, "Extensions for User Files"](#), on page 110 for an overview of the supported file extensions.

The user data can be roughly divided into the following data types:

- Settings
Settings, e.g. the frame setting of the GSM/EDGE standard, can be loaded and current setting saved to the specified file.
- Complex modulation and control data
User data of this type can be loaded. It can be generated either externally or internally. For internal generation, a new list must be created which will then be edited in the

data and control list editor. These functions are offered in the "Data List Management" dialog of the individual modulation menu.

- **Waveforms**
Waveforms are generated externally (e.g. by means of the R&S WinIQSIM2 program that is supplied together with the optional Baseband Generator R&S AMU-B10) and can be loaded in the "Arbitrary Waveform Generation" dialog.



Softkeys are assigned to some of the functions and can be used for convenient operation.



For more information, refer to:

- [chapter 4.8, "Legend of Front-Panel Controls"](#), on page 112 for an overview of key functions and a cross-reference between the front panel keys and the keyboard shortcuts
- to "Instrument Functions" in the Operating Manual for a detailed description of key functions.

Accessing files with user data

1. To access an editable user data file, select the "Save/Recall" or "File Manger" function in the individual dialog.



2. To access a loadable data file, select the "Select/New" or "File Manager" function in the individual dialog.

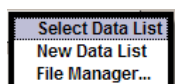

3. To access the "File Manager" function, press the SETUP (CTRL+E) key and select "Save/Recall > File Manager".

A "File Select" window for loading, saving or creating a file or the "File Manager" dialog for managing all files is displayed.



Saving and loading of all instrument settings

All instrument settings are saved and loaded in the "File" menu.

To access the "File" menu, press the FILE (CTRL+S) key.

For more information, see chapter "Storing and Loading Instrument Data - File Key" in the Operating Manual.

4.7.1 File Select Dialog

The "Save/Recall" dialog displays the available drives and directories. In the upper part, "Recent Data Sets", the files last used are listed.

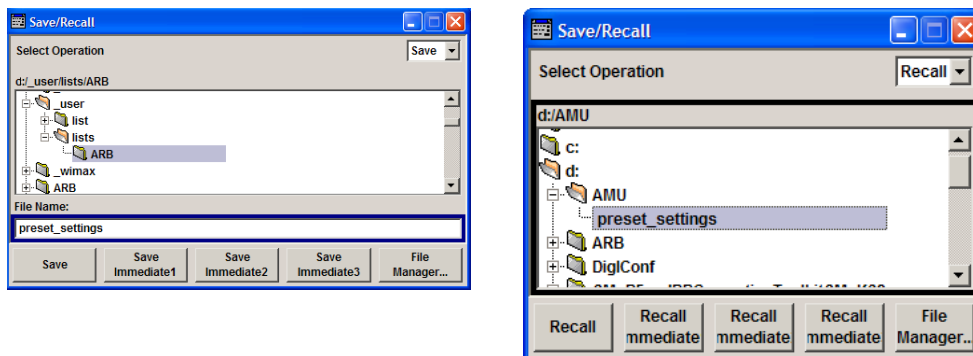

The available drives and directories and the files of the selected directory are displayed. The currently selected path is displayed above the window. Only the relevant files without file extensions are displayed. If the area is opened several times, the path last selected is displayed. When a file is saved or created, its name is user-selectable; the extension is assigned automatically and cannot be entered. The file is saved to the selected path.

In addition to the files saved by the user, some menus also offer files containing predefined contents. These files are saved to a specific directory on system drive; for this reason, this directory cannot be chosen from the "File Select" menu.

Example:

The following example shows the "File Select" menu of the GSM/EDGE digital standard when "Recall Predefined Frames" is selected.

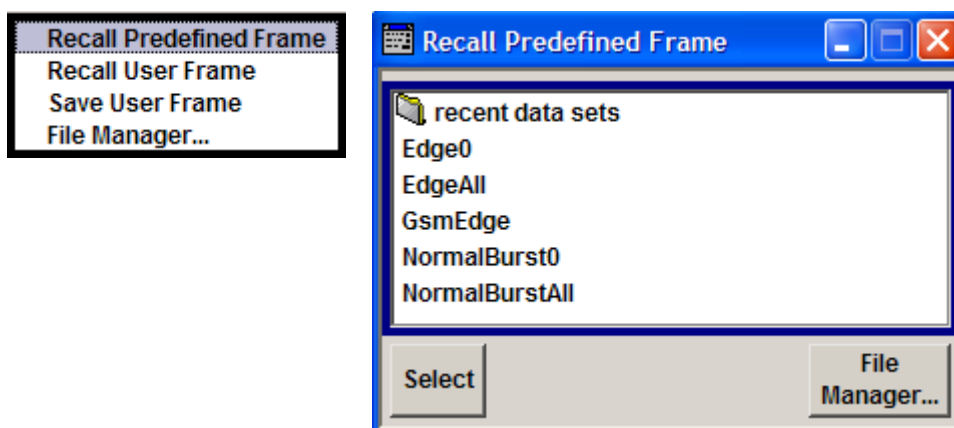

Working with the File Select dialog

1. Access the "File Select" dialog (see ["Accessing files with user data"](#) on page 107).
2. Navigate in the "File Select" dialog.
3. Load an existing file.

In the "Recall Settings" dialog, mark a file and press the "Select" button.

4. Save a file.

In the "Save Settings" dialog, enter file name in the "File Name:" field.

Select the directory to which the file is to be saved and then select the "Save" button.

5. Create a new file.

To create a new file, use the "Save Settings" functionality, i.e. specify file name and directory and save the file.

The created file is empty; it must be filled with the necessary values in the individual editor.

4.7.2 File Manager

The "File Manager" allows general file management such as copying, shifting, renaming and deleting files as well as generating new directories.

Thus, also externally created files, for example waveforms created by using the R&S®WinIQSIM2 program, can be saved to the R&S AMU by copying them from a memory stick or a network to the internal hard disk.

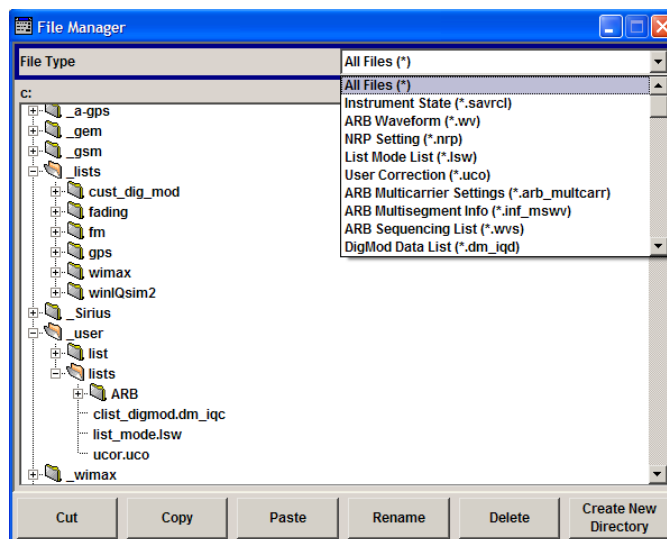

Use the "File Type" to select a file type from the list. This can be used to process either all files (all files (*) selection) or a specific selection of files. See [chapter 4.7.2.1, "Extensions for User Files"](#), on page 110 for an overview of the supported file extensions. The available drives and directories and the files of the selected directory are displayed. The currently selected path is displayed above the windows. If the area is opened several times, the path last selected is displayed. Unlike the "File Select" window, the "File Manager" displays the full file names including extensions.

Working with the File Manager dialog

1. Accessing the "File Manager" dialog (see ["Accessing files with user data"](#) on page 107).

2. Navigating in the "File Manager" dialog.
Operation is similar to the operation of menus with several areas.
3. Moving, duplicating, deleting or renaming files
To move a file, select the file and press the "Cut" button. Mark the directory to which the file is to be moved and select the "Paste" button. If the target directory already contains a file with the same name, a confirmation query is displayed to confirm overwriting of this file.
Perform the similar steps and cut/copy/rename/delete the file.
Tip: The operation corresponds to the Windows concept.
4. Creating a new directory
Mark drive or directory level where the new directory is to be created, select the "Create New Directory" button and enter the name of the new directory in the entry window that opens. Confirm with ENTER.

4.7.2.1 Extensions for User Files

The following table list all available file extensions for user files. The currently available files on the instrument depends on the installed options.

Table 4-1: List of the automatically assigned file extensions in the instrument

Function/Digital Standard	List type	Contents	File suffix
Instrument State	Settings	Instrument settings	*.savrcl
"Arbitrary Waveform Generator"	Waveform	ARB waveforms ARB multi segment waveforms	*.wv
	Waveform	ARB multi carrier settings	*.arb_mult carr
	Configuration data	Configuration file for creation of multisegment ARB waveforms	*.inf_mswv
	Play List	ARB Sequencing List	*.wvs
"DM"	Data List	Digital modulation data	*.dm_iqd *.tdm
	Control List	Data to control digital modulation	*.dm_iqc
	Settings	Digital modulation settings	*.dm
	User Standard	Digital modulation user standard	*.dm_stu
	User Mapping	Digital modulation user mapping	*.vam
	User Filter	Digital modulation user filter	*.vaf
EX-IQ-Box	User Settings	EX-IQ-Box User Defined Settings	*.iqbox
"Fading"	Fading	Fading data	*.fad
"GSM/EDGE"	Settings	GSM/EDGE settings	*.gsm
	Slot	User-defined slot data	*.gsm_slu

Function/Digital Standard	List type	Contents	File suffix
	Frame	User-defined frame data	*.gsm_fu
	Slot	Higher symbol rate slot	*.gsm_hslu
	Frame	Higher symbol rate frame	*.gsm_hfu
"Bluetooth"	Bluetooth Settings	Complete setting of the Bluetooth menu	*.bto
"TETRA"	TETRA Settings	Complete setting of the TETRA menu	*.tetra
"3GPP FDD"	Settings	Complete setting of the 3GPP (FDD) menu	*.3g
	Settings	Channel coding enhanced DPCH channels (downlink)	*.3g_ccod_dl_s
	Settings	Channel coding enhanced DPDCH channels (uplink)	*.3g_ccod_ul
"CDMA2000"	Settings	Complete setting of the CDMA2000 menu	*.cdma2k
"TD-SCDMA2000"	Settings	Complete setting of the TD-SCDMA2000 menu	*.tdscdma
	Settings	Test Model for TD-SCDMA2000	*.tdtmd
1xEV-DO	Settings	Complete setting of the 1xEV-DO menu	*.evdo
"IEEE 802.11 WLAN"	Settings	Complete setting of the IEEE 802.11 WLAN menu	*.wlan
"IEEE 802.11 n WLAN"	Settings	Complete setting of the IEEE 802.11n WLAN menu	*.wlann
	Settings	Beamforming data	*.bmf
"IEEE 802.16 WiMAX"	Settings	Complete setting of the IEEE 802.16 WiMAX menu	*.wimax
"EUTRA/LTE"	Settings	Complete setting of the EUTRA/LTE menu	*.eutra
	Settings	TDD Settings	*.lte_tdd
	Settings	User-defined IQ-File	*.iqw
"GPS"	Settings	Complete setting of the GPS/A-GPS menu	*.gps
	Settings	GPS Almanac Settings	*.txt *.alm *.al3
	Settings	GPS Waypoints File	*.txt
	Settings	GPS Generated Almanac File	*rs_al *.rs_yuma
	Settings	GPS Ionospheric File	*.rs_ion
	Settings	GPS Navigation Data	*.rs_nav
	Settings	GPS UTC File	*.rs_utc *.rs_acq

Function/Digital Standard	List type	Contents	File suffix
"FM-Stereo"	Settings	Complete setting of the FM-Stereo menu	*.fmstereo
	Settings	FM-Stereo Group Type Settings	*.fm_gt
	Settings	FM-Stereo Group Hex Type Settings	*.fm_ghex
	Waveform File	Waveform File	*.wav
"Sirius"	Settings	Complete setting of the Sirius menu	*.sirius
"XM-Radio"	Settings	Complete setting of the XM-Radio menu	*.xmradio
	Settings	XM-Radio TWTA Data	*.twta
"DVB"	Settings	Complete setting of the DVB menu	*.dvb
	Settings	DVB Transport Stream	*.gts *.ts *.trp
"DAB/T-DMB"	Settings	Complete setting of the DAB/T-DMB menu	*.dab
	Settings	DAB ETI Files	*.eti *.xeti

4.8 Legend of Front-Panel Controls

The following table lists all key functions available on the front panel. Key combinations used on the PC keyboard to trigger key functions on the instrument front panel are also described. Keyboard labels are described in alphabetical order.

In addition, a front panel key emulation and an on-screen keyboard can be used for manual operation by mouse only.

Table 4-2: Cross-reference between the front panel keys and keyboard shortcuts

Front-panel key	Key of PC keyboard	Function
Turning the rotary knob	Tab key (towards the right) Shift + Tab (towards the left)	Sets the cursor with the rotary knob.
Pressing the rotary knob	Enter	Pressing the rotary knob confirms an entry; it has the same function as the ENTER key.
Arrow keys	Arrow keys	Moves the cursor.
*1 / dB(m)	ALT + F12	Confirms entries in the base unit and values without a unit. The unit dBm is inactive.
. / *...#	. / *...#	Enters a period/decimal point. Enters a special character.
+/- / A<->a	- / (shift+) a—z	Enters the sign. Switches between upper-case and lower-case letters.

Legend of Front-Panel Controls

Front-panel key	Key of PC keyboard	Function
0-9 / a...z	CTRL+ 0-9 / a...z CTRL	Enters the number/letter.
BACKSPACE	Backspace	Clears the last entry (number, sign or decimal point)
CLOSE	CTRL + G	Closes an active menu.
DIAGRAM	CTRL+ D	Sets the cursor on the block diagram and hides all menus.
ENTER	Enter	Terminates an entry.
ESC	ESC	Selects the next higher menu/selection level. When the editing mode is exited with ESC, the previous value is restored.
FILE	CTRL + S	Activates the menu for storing instrument settings.
BASEBD LEVEL	CTRL+ L	Activates the frequency entry.
BASEBD ON/OFF	CTRL + R	Switches the baseband output signal on and off. In the two-path mode the BASEBD ON/OFF key switches all signals off. A second stroke restores the status that was active before the last switch off. "I/Q OUT OFF" is displayed in the status bar.
G/n / dBuV	ALT + F9	Selects the unit Giga/Nano. The unit dBuV is inactive.
HCOPY	CTRL+ Y	Opens the menu for configuring and starting a hard-copy.
HELP	F1	Opens/closes context-sensitive help.
HIDE	CTRL+ H	Minimizes the active menu. Pressing the respective button in the Winbar opens the menu again.
INFO	CTRL + I	Opens/closes the info window
INSERT	Ins	Activates the insert mode.
k/m / uV	ALT + F11	Selects the units Kilo/Milli and uV for levels.
LOCAL	CTRL + Q	Switches the instrument from remote control to manual control.
M/u / uV	ALT + F10	Selects the units Mega/Micro and uV for levels.
MENU	CTRL + M	Calls the menu selection list.
ON/OFF TOGGLE	CTRL + T	Switches a block or parameter on/off. Toggles between the different possibilities of setting a selection parameter.
PRESET	CTRL + P	Restores a defined basic instrument setup.
REARR	CTRL + A	Adjusts the size of the active menu to use the whole height of the display.
RECALCULATE	CTRL + C	Starts recalculation of the signal.
SETUP	CTRL + E	Opens the setup menu for general instrument settings.

Front-panel key	Key of PC keyboard	Function
Softkeys	CTRL + F1 – F8	Triggers the function assigned to the softkey.
WINBAR	CTRL + W	Displays the Winbar in the foreground/background.

4.8.1 Front Panel Key Emulation

The R&S AMU provides a front panel key emulation to enable execution of the front panel key functions by mouse e.g. for remote access. The emulation is called by a right mouse click. The front panel key functions are executed by a mouse click on the associated button.



4.8.2 On-screen Keyboard

In addition, the Windows XP operating system provides a keyboard emulation that can be used for system settings if no external keyboard but a mouse is available.

To access the on-Screen Keyboard, select "Start > Programs > Accessories > Accessibility > On-Screen Keyboard".



A Hardware Interfaces

This section covers hardware related topics, like pin assignment of the GPIB bus interface, monitor and AUX I/O connectors.

The remote control interfaces are described in details in the Operating Manual, section "Remote Control Basics".

All other interfaces are described in [chapter 2.1, "Front Panel Tour"](#), on page 11 and [chapter 2.2, "Rear Panel Tour"](#), on page 19.

For specifications refer to the data sheet.

A.1 GPIB Bus Interface

Pin assignment

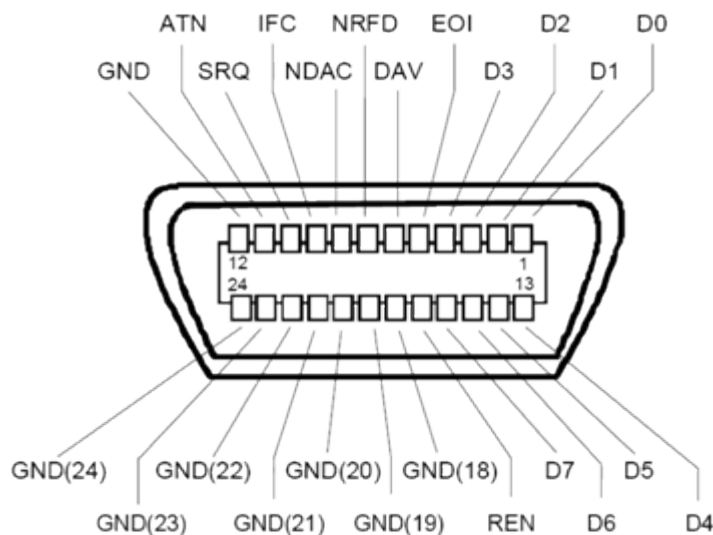

Fig. 1-1: Pin assignment of GPIB bus interface

Bus lines

- Data bus with 8 lines D0 to D7:
The transmission is bit-parallel and byte-serial in the ASCII/ISO code. D0 is the least significant bit, D7 the most significant bit.
- Control bus with five lines:
IFC (Interface Clear): active LOW resets the interfaces of the instruments connected to the default setting.
ATN (Attention): active LOW signals the transmission of interface messages, inactive HIGH signals the transmission of device messages.

SRQ (Service Request): active LOW enables the connected device to send a service request to the controller.

REN (Remote Enable): active LOW permits switchover to remote control.

EOI (End or Identify): has two functions in connection with ATN:

- ATN=HIGH active LOW marks the end of data transmission.
- ATN=LOW active LOW triggers a parallel poll.

- Handshake bus with three lines:

DAV (Data Valid): active LOW signals a valid data byte on the data bus.

NRFD (Not Ready For Data): active LOW signals that one of the connected devices is not ready for data transfer.

NDAC (Not Data Accepted): active LOW signals that the instrument connected is accepting the data on the data bus.

Interface Functions

Instruments which can be controlled via GPIB bus can be equipped with different interface functions. The interface function for the R&S AMU are listed in the following table.

Table 1-1: GPIB bus interface functions

Control character	Interface function
SH1	Handshake source function (source handshake), full capability
AH1	Handshake sink function (acceptor handshake), full capability
L4	Listener function, full capability, de-addressed by MTA.
T6	Talker function, full capability, ability to respond to serial poll, deaddressed by MLA
SR1	Service request function (Service Request), full capability
PP1	Parallel poll function, full capability
RL1	Remote/Local switch over function, full capability
DC1	Reset function (Device Clear), full capability
DT1	Trigger function (Device Trigger), full capability

A.2 AUX I/O Connector



For an overview of the signals that can be applied at the USER connector, see section "User Marker / AUX I/O Settings" (table "USER Connector Signals") in the Operating Manual.

Table 1-2: Pin assignment of the AUX I/O Connector connector

Pin	Signal	Description
1 .. 25	Ground \perp	Ground
26	FHOP_CLK	Currently, not active, but reserved for future use of the corresponding signal.

Pin	Signal	Description
27	FHOP_DATA	Currently, not active, but reserved for future use of the corresponding signal.
28	BURST_GATE_A	Currently, not active, but reserved for future use of the corresponding signal.
29 .. 38	PARDATA0 .. PARDATA9	Parallel data input/output 0...D with 10-bit word width for digital modulation. If the data source "External Parallel" is selected, these pins are the data inputs. If a different data source is selected, the data is output here ("Custom Digital Modulation", Path A).
39	USER 3	USER input/output which can be configured for various purposes. The following signals can be applied to the pin: <ul style="list-style-type: none"> • Marker 4 (output path A or path B) • CW Mode Out (output path A or path B) • FHOP_STRB (output path A or B) This signal marks the trigger for frequency hopping by processing of ARB sequences. • Trigger (output path A or path B) This signal marks the trigger event caused by the selected trigger signal (internally or externally) of path A or B. Additional signals for path B are available in two-path instruments. The signals corresponding to path A are applied at the pins of the AUX I/O interface (Clock Out). • Clock Out (output Path B; bit or symbol clock pulse) This signal corresponds to the clock signal for digital modulations. • LEV ATT (input/output path B) • BURST (input/output path B)
40	USER 4	USER input/output which can be configured for various purposes.
41	BURST	Signal output/input for controlling the burst ramp, path A. With external envelope curve control ("Custom Digital Modulation" only), the pin is the input for the control signal BURST_RAMP. With internal envelope curve control, the control signal BURST_RAMP is output for path A. For two-path instruments, the signal for path B can be applied to one of the user interfaces.
42	MARKER 3 A	Output for the freely programmable marker signal 3 of path A. The output is permanently assigned.
43	MARKER 3 B	Output for the freely programmable marker signal 3 of Path B. The output is permanently assigned.
44	LEV ATT	Signal input/output for controlling the level attenuation. For two-path instruments, the signal for Path B can be applied to one of the USER interfaces. With external envelope curve control ("Custom Digital Modulation" only), the pin is the input for the control signal LEV_ATT. With internal envelope curve control, the control signal LEV_ATT is output for Path A.
45	FHOP_STRB	Currently not active, but reserved for future use of the signals
46	BURST_GATE_B	Currently not active, but reserved for future use of the signals

Pin	Signal	Description
47	BITCLK	Output Bit clock for internal mode. For two-path instruments, the signal for Path B can be applied to one of the USER interfaces.
48	USER 2	USER input/output which can be configured for various purposes.
49	SYMBCLK	Symbol clock output for internal mode. With two-path instruments, the signal for Path B can be applied to one of the USER interfaces.
50	not used	not used

A.3 Monitor Connector (MONITOR)

The 15-pin Sub-D female connector MONITOR at the rear panel is intended for connecting an external VGA monitor.

Table 1-3: Pin assignment of the MONITOR connector

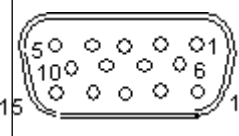
Monitor Connector	Pin	Signal	Pin	Signal	Pin	Signal
	1	Red (output)	6	GND	11	(NC)
	2	Green (output)	7	GND	12	(NC)
	3	Blue (output)	8	GND	13	HSYNC (output)
	4	(NC)	9	GND	14	VSYNC (output)
	5	GND	10	GND	15	(NC)

A.4 BERT Connector

The 9-pin Sub-D connector BERT at the rear panel is available for the input signals of the integrated bit error rate tester (option BER/BLE Measurement (R&S AMU-K80)).

Table 1-4: Pin assignment of the BERT connector

Monitor Connector	Pin	Signal	Pin	Signal
	1	GND	6	CLOCK
	2	GND	7	DATA
	3	GND	8	DATA ENABLE
	4	GND	9	RESTART
	5	GND		

The input signals are not terminated in the instrument. The impedance (50 ohm) and the threshold (0.0128..1.998 V) of the inputs can be set in the "BERT" menu.

The following figure shows the circuit diagram of the BERT function.

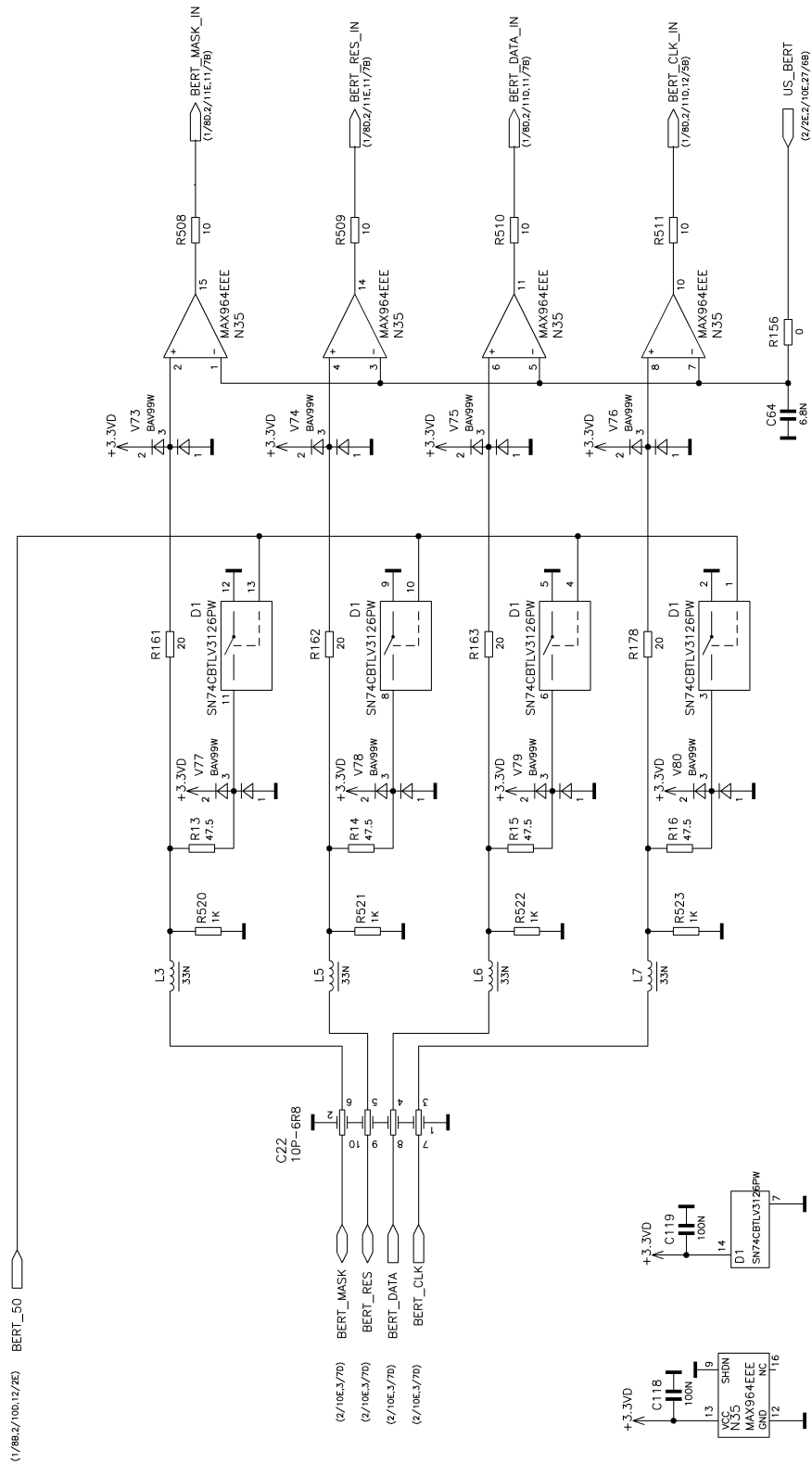

Fig. 1-2: BERT circuit diagram

Index

A

Abort button	99
Abort calculation	99
Access denied	90
AC supply	20
Additional White Gaussian Noise (option R&S AMU-K62)	64
Architecture of the instrument	57
Arrow keys	17
ATN	115
Attention	115

B

Baseband generator (option R&S AMU-B9/B10/B11)	64
Baseband input module (option R&S AMU-B17)	64
Baseband main module (option R&S AMU-B13)	64
Baseband section	63
BITCLK	118
BURST	117
BURST_GATE_A	117
BURST_GATE_B	117

C

Computer name	
Changing	36
Connection to an external controller	38
Connector	
AUX I/O	23
Baseband digital input	23
Baseband digital output	23
BERT	23
CLOCK	18
CLOCK IN	22
CLOCK OUT	22
DATA	18
DATA IN	22
DATA OUT	22
GPIB	21
I	17
I BAR	17
I BAR OUT	20
IEC/IEEE	21
I IN	20
INSTR TRIG	20
I OUT	20
LAN	19
MARKER 1A, 2A	18
MARKER 1A/2A, 1B/2B	21
Monitor	22
Q	17
Q BAR	17
Q BAR OUT	20
Q IN	20
Q OUT	20
REF IN	22
REF OUT	22
RESERVE	21
TRIGGER 1	18
TRIGGER 1, 2	22

USB	18
USB type A	23
USB type B	23
USER	21
Control bus	115
Controller, external	38
Cursor keys	17
CW Mode	117

D

DATA	117
Data Valid	115
DAV	115
Default instrument settings	28
DHCP	35
Differential output module (option R&S AMU-B16)	65
Digital output module (option R&S AMU-B18)	65
Display	84
Documentation Overview	7

E

EOI	115
Error messages	86
Examples of application	59

F

Fading module (option R&S AMU-B14)	65
FHOP_CLK	116
FHOP_DATA	117
FHOP_STRB	117
Frequency display	84
Front panel key emulation	114
Fuses	26

G

Getting started	57
-----------------------	----

I

I/Q Out block	67
IFC	115
INFO key	86
Input	
BURST	117
CW Mode	117
DATA	117
LEV-ATT	116, 117
USER 2	118
USER 3	117
USER 4	117
Input connector	17, 18, 20, 21, 22, 23
Interface	
functions (GPIB bus)	116
Interface Clear	115
IP address	
Changing	35
Remote Desktop	42

K

Key

Arrow key	17
BACKSPACE	16
BASEBD LEVEL	14
BASEBD ON/OFF	14
CLOSE	15
Cursor key	17
DIAGRAM	14
ENTER	16
ESC	15
FILE	14
HCOPY	12
HELP	13
HIDE	15
INFO	12
INSERT	16
LOCAL	12
MENU	15
ON/OFF	15
PRESET	12, 28
REARR	15
RECALCULATE	14
SETUP	12
TOGGLE	15
WINBAR	15
Keyboard emulation	114
Key combinations	112
Keypad	15

L

LAN

Configuration	34
LEV ATT	116, 117
Level display	84
Linux controller	43
Login	
Operating system	33
LXI	
Browser interface	52
Configuration	50
LAN configuration	53
Ping	54

M

Manual Remote Control	38
MARKER 3A	117
MARKER 3B	117
Menu structure	
access denied	90
header	90
menu area	90
Modular design	57

N

Navigation keys	17
NDAC	115
NRFD	115

O

Online help

Working with	104
--------------------	-----

Operating concept	57
Operating system	32
Login	33
service packs	33

Output

BITCLK	118
BURST	117
DATA	117
LEV-ATT	116, 117
MARKER 3A	117
MARKER 3B	117
SYMBCLK	118
USER 2	118
USER 3	117
USER 4	117
Output connector	17, 18, 20, 21, 22, 23

P

Password

Remote Desktop	42
Peak envelope power PEP	85
Ping	54
Point-to-point connection	34
Preset	28
Preset instrument settings	28

R

Rackmounting	26
Remote access	38
Remote Desktop	40
Remote operation	40
REN	115
Reserve connector	21
Reset instrument settings	28
Rotary knob	17

S

Service packs	33
Setting not possible	90
Setting parameters	92
Softkey	89
SRQ	115
Standby mode	13
Symantec Antivirus	49
SYMBCLK	118

U

Ultr@VNC	43
Units	
Input	15
UNIX controller	43
USER 2	118
USER 3	117
USER 4	117
User ID	
Remote Desktop	42

V

Virus protection	32
Virus-Protection Software	49
VNC connection	43

W

Warnings	86
Winbar	89
Windows XP	32
access	33